

# SIS MIXER ANALYSIS WITH NON-ZERO INTERMEDIATE FREQUENCIES

**S.-K. Pan and A. R. Kerr**  
National Radio Astronomy Observatory\*  
Charlottesville, VA 22903

## ABSTRACT

Most design and analysis of Superconductor-Insulator-Superconductor (SIS) mixers has been based on Tucker's quantum theory of mixing, always with the assumption of a zero intermediate frequency. This paper relaxes the zero IF constraint and explores the performance of SIS mixers at intermediate frequencies which are a significant fraction of the LO frequency.

The complete expression for the elements of the admittance matrix [Y] of a quantum mixer has been given by Tucker [1]. Examination of this expression shows that for a non-zero IF the symmetry of the admittance matrix elements between opposite sidebands, *i.e.*,  $Y_{m,n} = Y_{-m,-n}^*$ , is broken by the quantization of the IF. Therefore, the conversion gain and noise temperature of opposite sidebands will be different. Also, the output impedance of the mixer is no longer real and the output reactance varies as a function of the IF. In this study a quasi five-frequency approximation to Tucker's theory (*i.e.*, sinusoidal LO and five small-signal sidebands with non-zero IF) is used to simulate the performance of SIS mixers at different intermediate frequencies. It is found that the zero-IF approximation is appropriate for  $IF/LO < 0.1$ . The SIS mixer itself should be capable of excellent performance for a very wide IF bandwidth (20% to 30% of the LO frequency) and the design of an optimum coupling network between the mixer and IF amplifier should be straightforward.

---

\*The National Radio Astronomy Observatory is a facility of the National Science Foundation operated under cooperative agreement by Associated Universities, Inc.

## I. INTRODUCTION

SIS mixer technology has progressed very rapidly in the past few years. SIS receivers are now well established as the most sensitive receivers over much of the millimeter and submillimeter spectrum, and have been used on almost all millimeter- and submillimeter-wave radio telescopes around the world.

The development of SIS mixer technology has been guided mainly by Tucker's quantum mixing theory which predicts non-classical behavior — quantum-limited sensitivity, negative input and output impedance and conversion gain — in a resistive mixer with a sharp I-V characteristic. Although Tucker's theory provides a complete framework for understanding the behavior of SIS mixers, due to its complexity, the quantum mixing theory has always been applied with the assumption of a zero intermediate frequency (IF). The output (IF) frequency of most existing millimeter-wave astronomy receivers is much smaller than the input (RF) frequency, and the IF photon voltage ( $\hbar\omega_{IF}/e$ ) is small compared with the voltage scale of junction's dc nonlinearity. In such cases the intermediate frequency is sufficiently small and the zero-IF assumption is justified. For applications such as continuum observations, a very wide IF would actually be preferable, and the validity of the zero-IF assumption needs to be reexamined. Millimeter- and submillimeter-wave receivers with an extremely wide IF (~ several tens of GHz) would have the advantage that a wide RF bandwidth could be covered by a single fixed-frequency LO, which substantially simplifies the design of the LO system.

The aim of this paper is to use Tucker's theory, without the zero-IF assumption, to examine the behavior of SIS mixers with high IF's.

## II. SIMULATIONS

We have investigated the behavior of SIS mixers as functions of IF at two different LO frequencies, 115 and 345 GHz, and with various source and load impedances. In order to compare the results of this work to the zero-IF case studied in our earlier paper [2], we use the same I-V curve, that of a 4-junction array of Nb/Al-Al<sub>2</sub>O<sub>3</sub>/Nb junctions fabricated by Hypres, shown in Fig. 1. (Tucker's theory for single junction can be applied to an N junction array by scaling the induced photon step, current and voltage scale by a factor of N.)

We assumed that: (1) the array is voltage-biased at the center of the first photon step below the gap voltage; *i.e.*,  $V_0 = V_{gap} - N\hbar\omega_p/2e$  where  $V_{gap}$  is the gap voltage of the array, N is the number of junctions in the array and  $\omega_p$  is the LO frequency, and (2) the pumping parameter  $\alpha = eV_1/N\hbar\omega_p = 1.2$ , where  $V_1$  is the amplitude of the LO voltage at frequency  $\omega_p$ .

Although the analytical forms of the complete expressions for the elements of the admittance matrix [Y] and the noise current correlation matrix [H] of a tunnel junction mixer have been derived by Tucker [1] using a perturbation technique, certain approximations can be made to reduce computational effort in calculating these elements. In an earlier paper [2], we showed that, for most practical design parameters, the behavior of a SIS mixer with a zero-IF could be modeled quite accurately using Tucker's theory assuming a quasi five-frequency approximation in which five small-signal sidebands are allowed but the LO voltage is assumed sinusoidal. In this paper we extend this approach by including the intermediate frequency as an independent parameter. Using this model, the 5x5 small-signal admittance matrix elements  $Y_{m,n}$  and current correlation matrix elements  $H_{m,n}$  of our hypothetical mixer can be calculated directly from the closed-form expressions given in Tucker and Feldman's paper [3].

As explained in [2], the quasi five-frequency approximation assumes that the embedding impedance seen by the junction is finite at IF ( $\omega_{IF}$ ), the upper and

lower sidebands ( $\omega_p \pm \omega_{IF}$ ), the second harmonic sidebands ( $2\omega_p \pm \omega_{IF}$ ), but the second LO harmonic ( $2\omega_p$ ) is short-circuited at the junction (LO voltage waveform is sinusoidal). In the present work, we further assume that (1) at the second harmonic sidebands, the junction is terminated by the junction capacitance only, (2) the junction capacitance is tuned out at IF by the load susceptance and at both the upper and lower sidebands by the source susceptance, (3) both upper and lower sidebands are terminated by the same source conductance (*i.e.*,  $Y_{USB} = G_S = Y_{LSB}$ ) and (4) the RF source and IF load conductance are equal. This is shown in Fig. 2. Although these assumptions may be difficult to implement in a real mixer, they provide a convenient simplification for this initial study of the effects of high intermediate frequencies.

Also, for simplicity, only the case of  $\omega_p R_N C = 4$  is examined in this work ( $R_N$  is the normal resistance of the junction (array) and  $C$  is the junction (array) capacitance). The accuracy of the quasi five-frequency approximation is very good for  $\omega_p R_N C \geq 4$ , and, because the junction capacitance is tuned out at IF and the signal and image frequencies, the value of  $\omega_p R_N C$  should have very little effect on the mixer performance as a function of the intermediate frequency.

Three different values of  $R_{RF}$  (the reciprocal of the source conductance, *i.e.*,  $R_{RF} = 1/G_S$ ) are used in the simulations for each LO frequency:  $R_{RF} = 0.2 * R_N$ ,  $0.6 * R_N$  and  $1.0 * R_N$  for 115 GHz and  $R_{RF} = 0.6 * R_N$ ,  $1.0 * R_N$  and  $1.4 * R_N$  for 345 GHz. The mixer conversion gain, noise temperature, input return loss and output admittance are calculated in each case as functions of the normalized intermediate frequency (IF/LO).

### III. RESULTS

The conversion gain of 115 GHz and 345 GHz mixers is shown in Figs. 3(a)-(b). As expected, the upper sideband (USB) gain and the lower sideband (LSB) gain are not equal. At low IF, the USB and LSB gains converge to the zero-IF results given in [2]. For  $IF/LO < 0.3$ , the LSB gain increases as  $IF/LO$  increases, while the USB gain decreases. At  $IF/LO = 0.3$ , the difference in gains is 2-3 dB. The gain of both sidebands drops very quickly for  $IF/LO > 0.5$ .

Figs. 4(a)-(b) show the equivalent input noise temperatures of the mixers. Differences in noise temperature between two sidebands are less than 5 K for  $IF/LO < 0.3$  but increase very rapidly for  $IF/LO > 0.5$ .

The input return loss of the same mixers is shown in Figs. 5(a)-(b). In each case the return loss is reasonable for  $IF/LO < 0.3$ ; the worst RF input match occurs between  $IF/LO = 0.4$  and  $0.6$ .

The output admittance of the mixer is computed for each case and converted into the reciprocal output conductance ( $R_{out} = 1/G_{out}$ ) and the reciprocal output susceptance ( $X_{out} = 1/B_{out}$ ). These data are then normalized to the reciprocal load conductance ( $R_{if} = 1/G_{if}$ ) and plotted in Figs. 6(a) and (b). In general, the mixer output impedance is large, but no longer real, and the output reactance is capacitive.

Since the output of the mixer is capacitive, it can be represented, as shown in Fig. 7, by a resistor  $R_{out}$  whose value is given in Figs. 6(a)-(b)) in parallel with a capacitor whose value is given in Figs. 8(a)-(b). Also plotted in these two figures, for comparison, is the junction capacitance. For  $IF/LO < 0.3$  the equivalent output capacitance is almost constant and is small compared to the junction capacitance. It shows a broad peak between  $IF/LO = 0.4$  and  $0.8$ .

The results presented above can be summarized as follows: the performance difference between the upper and lower sidebands is almost negligible and the zero-IF approximation is appropriate for  $IF/LO < 0.1$ . As  $IF/LO$  approaches 0.3, the difference between two sidebands becomes significant. The overall mixer performance deteriorates very rapidly for  $IF/LO > 0.5$ . The output admittance of the mixer is no longer real and the output susceptance is capacitive and varies as a function of  $IF$ .

#### IV. DISCUSSION

It is well-known that, in the zero-IF case, because of the quantization of the LO frequency, the behavior of an SIS mixer is completely determined by the current at only those voltages equal to the bias voltage plus multiples of  $\hbar\omega_p/e$  (i.e.,  $V = V_0 + n\hbar\omega_p/e$  where  $n = 0, \pm 1, \pm 2, \dots$ , which are called photon points). The matrix elements between opposite sidebands thus have the following symmetry:  $Y_{m,n} = Y_{-m,-n}^*$  and  $H_{m,n} = H_{-m,-n}$ . Furthermore, since the circuit external to the nonlinear mixer element (junction) does not distinguish between the signal and the image (i.e.,  $Y_{\text{signal}} = Y_{\text{image}}$ ), the mixer operates in the double sideband mode and the IF output impedance is real. In this paper we have shown that when the intermediate frequency is not zero, even though both sidebands of the mixer are terminated by the same source admittance, the mixer conversion gain, noise temperature, and the input return loss at the two sideband frequencies are different.

The behavior of the SIS mixers presented in this paper can be understood by examining the expression for the admittance matrix elements  $Y_{m,n}$  of the non-zero IF mixer given in [3]. These expressions consist of complicated Bessel series summations involving the junction's dc current,  $I_{dc}(V)$ , and its Kramers-Kronig transform,  $I_{KK}(V)$ , at not only the "photon points" given by  $V = V_0 + n\hbar\omega_p/e$ , but also at voltage points equal to the "photon points" plus/minus one IF photon, due to the quantization of the IF, i.e.,  $V = V_0 + n\hbar\omega_p/e \pm \hbar\omega_{IF}/e$ , where  $n = 0, \pm 1, \pm 2, \pm 3, \dots$ . This breaks the symmetry of the admittance matrix elements between opposite sidebands, i.e.,  $Y_{m,n} \neq Y_{-m,-n}^*$ . For the same reason, the noise current correlation matrix elements also lose their symmetry (i.e.,  $H_{m,n} \neq H_{-m,-n}$ ). Therefore, although the terminations at the upper and lower sidebands are identical, the performance of these two sidebands is different. Examination of these Bessel series summations also reveals that for typical values of the pumping parameter,  $\alpha$ , the first few terms, especially the ones involving the photon points at  $V = V_0 + n\hbar\omega_p/e \pm \hbar\omega_{IF}/e$  where  $n = 0$  and 1, dominate the Bessel sum for the  $Y_{m,n}$  and  $H_{m,n}$ . As  $IF/LO$  approaches 0.5, with the junction voltage biased at the center of the first photon step below the gap voltage, the photon points at  $V = V_0 + \hbar\omega_{IF}/e$  and  $V = V_0 + \hbar\omega_p/e - \hbar\omega_{IF}/e$  approach the gap voltage. This causes the mixer noise temperature to increase very rapidly, and the gain of the mixer to peak at  $IF/LO \sim 0.5$ . This argument also implies that the mixer's usable IF bandwidth decreases if it is biased at voltages other than the center of the photon step.

Recent work by S. Padin *et al.* of OVRO has demonstrated that it is possible to achieve good SIS receiver performance with moderately broad IF bandwidth ( $\sim 4$  GHz) using a simple coupling network between the SIS mixer and HFET IF amplifier [4]. The results presented in this paper show that the SIS mixer itself should be capable of excellent performance with a much wider IF bandwidth (20% to 30% of the LO frequency). Furthermore, because the equivalent output capacitance is almost constant and is small compared to the junction capacitance, the design of an optimum coupling network between the mixer and IF amplifier should be straightforward.

## V. ACKNOWLEDGMENT

The authors would like to thank Dr. Marian W. Pospieszalski for many helpful discussions.

## REFERENCES

- [1] J. R. Tucker, "Quantum limited detection in tunnel junction mixers," *IEEE J. Quantum Electron.*, vol. QE-15, no. 11, pp. 1234-1258, Nov. 1979.
- [2] A. R. Kerr, S.-K. Pan and Stafford Withington, "Embedding impedance approximations in the analysis of SIS mixers," *IEEE Trans. Microwave Theory Tech.*, vol. 41, no. 4, pp. 590-594, April 1993.
- [3] J. R. Tucker and M. J. Feldman, "Quantum detection at millimeter wavelength," *Rev. Mod. Phys.*, vol. 57, no. 4, pp. 1055-1113, Oct. 1985.
- [4] S. Padin, D. P. Woody, J. A. Stern, H. G. LeDuc, R. Blundell, C.-Y. E. Tong and M. W. Pospieszalski, "An integrated SIS mixer and HEMT IF amplifier," *Proc. of the Sixth Int. Symp. on Space Terahertz Tech.*, March 1995.

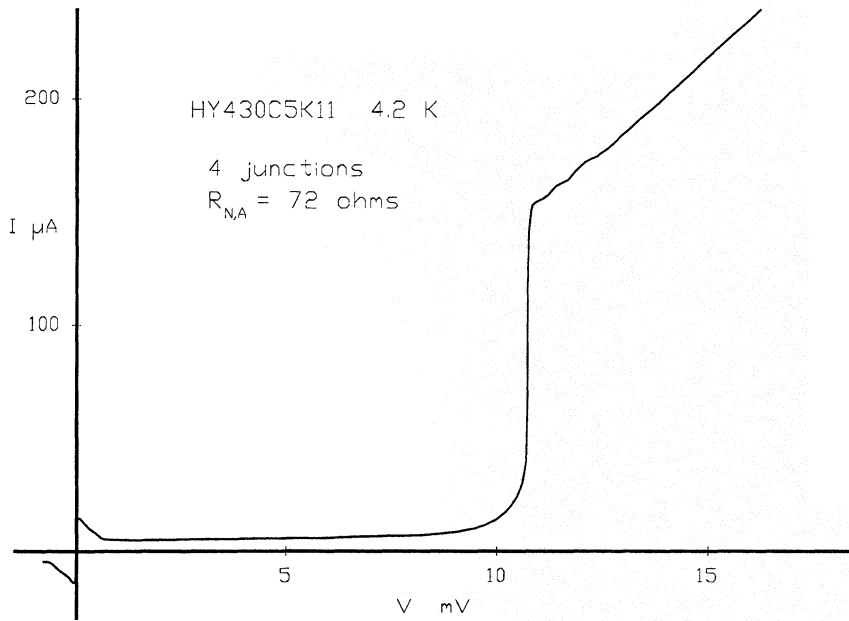

Fig. 1. I-V curve used in the simulations. This curve is for a series array of four Hypres Nb/Al-Al<sub>2</sub>O<sub>3</sub>/Nb junctions at 4.2 K, as used in [2].

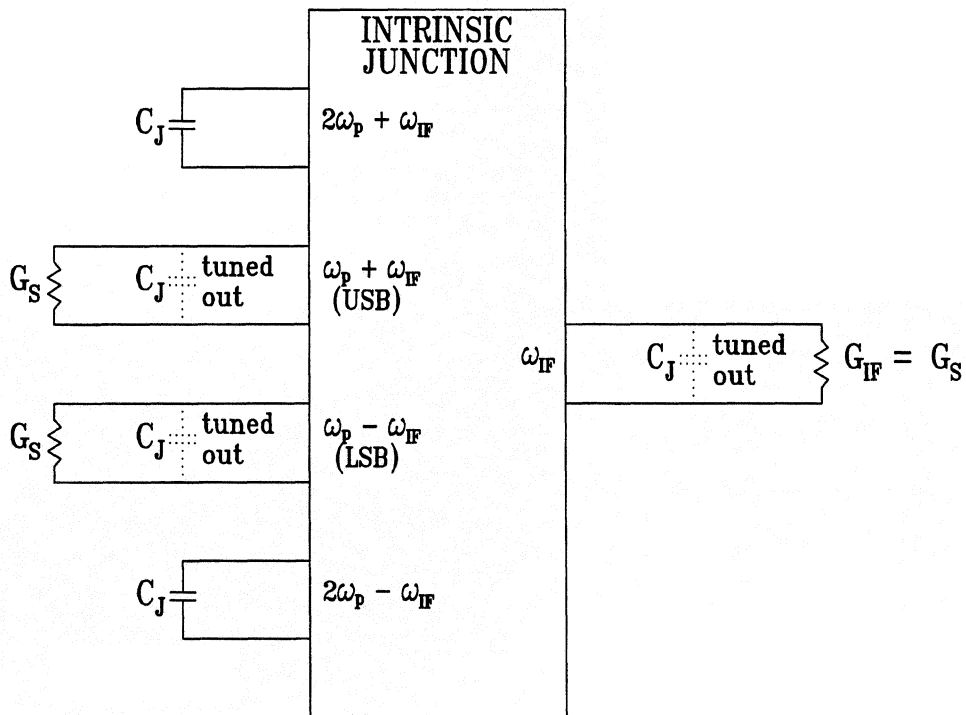

Fig. 2. The mixer's small-signal equivalent circuit showing the sideband terminations used in the simulation.

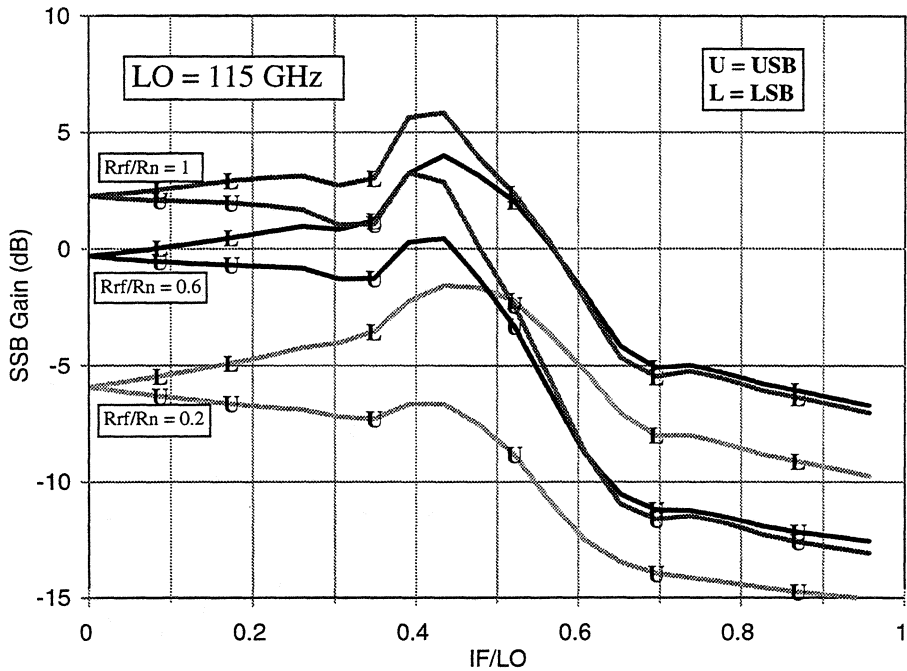

Fig. 3(a). Upper and lower sideband conversion gain as functions of IF/LO for a 115 GHz SIS mixer. Results are shown for  $R_{RF}/R_N = 0.2, 0.6$  and 1.

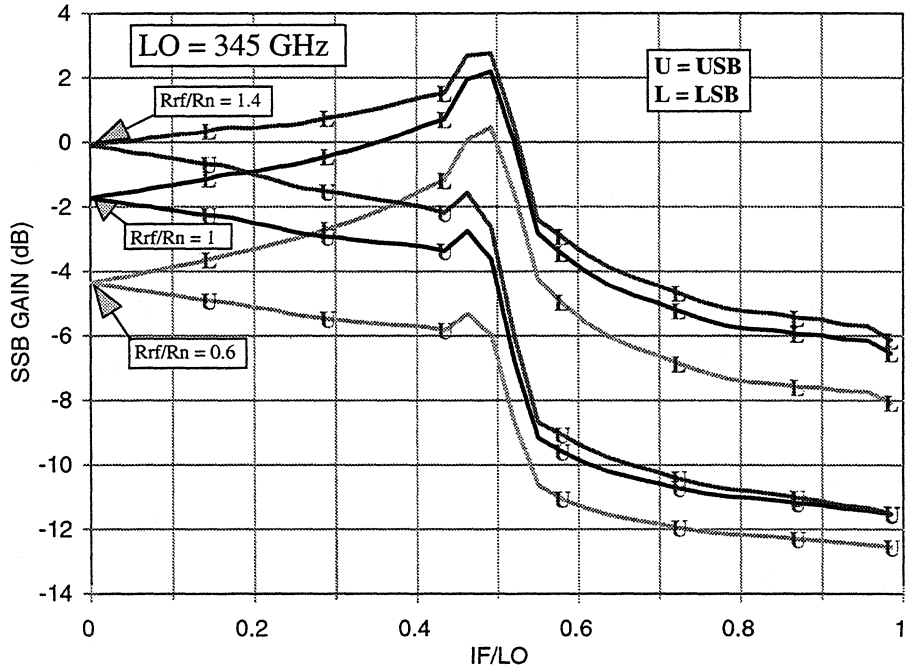

Fig. 3(b). Upper and lower sideband conversion gain as functions of IF/LO for a 345 GHz SIS mixer. Results are shown for  $R_{RF}/R_N = 0.6, 1$  and 1.4.

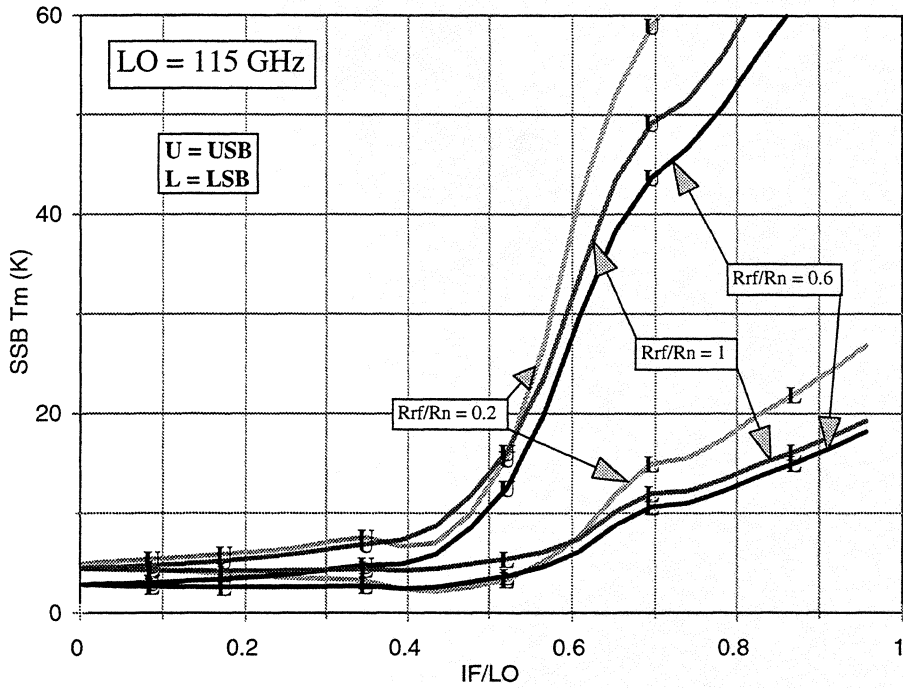

Fig. 4(a). Upper and lower sideband noise temperature as functions of IF/LO for a 115 GHz SIS mixer. Results are shown for  $R_{RF}/R_N = 0.2, 0.6$  and 1.

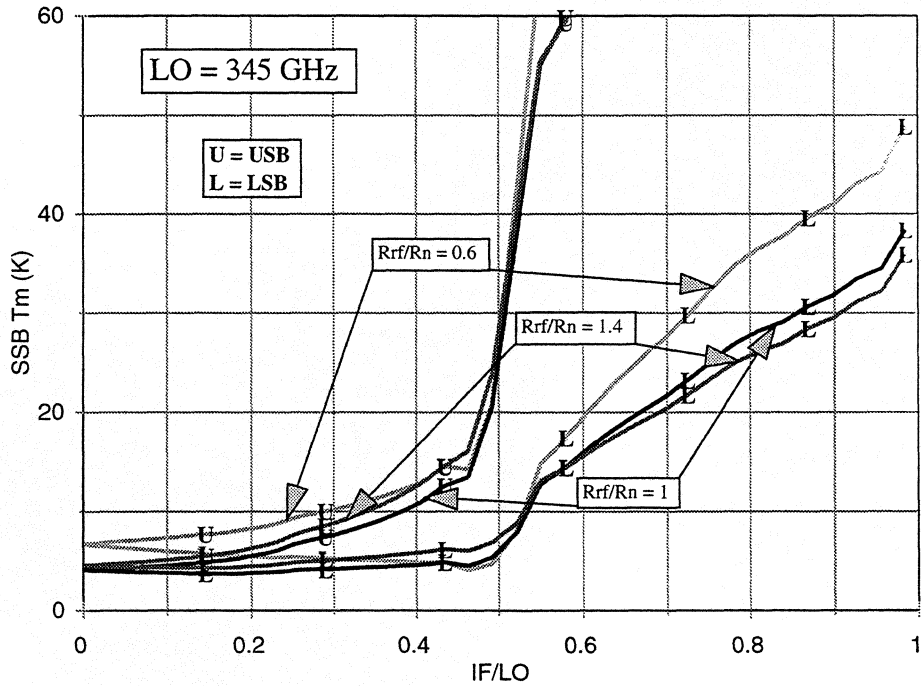

Fig. 4(b). Upper and lower sideband noise temperature as functions of IF/LO for a 345 GHz SIS mixer. Results are shown for  $R_{RF}/R_N = 0.6, 1$  and 1.4.



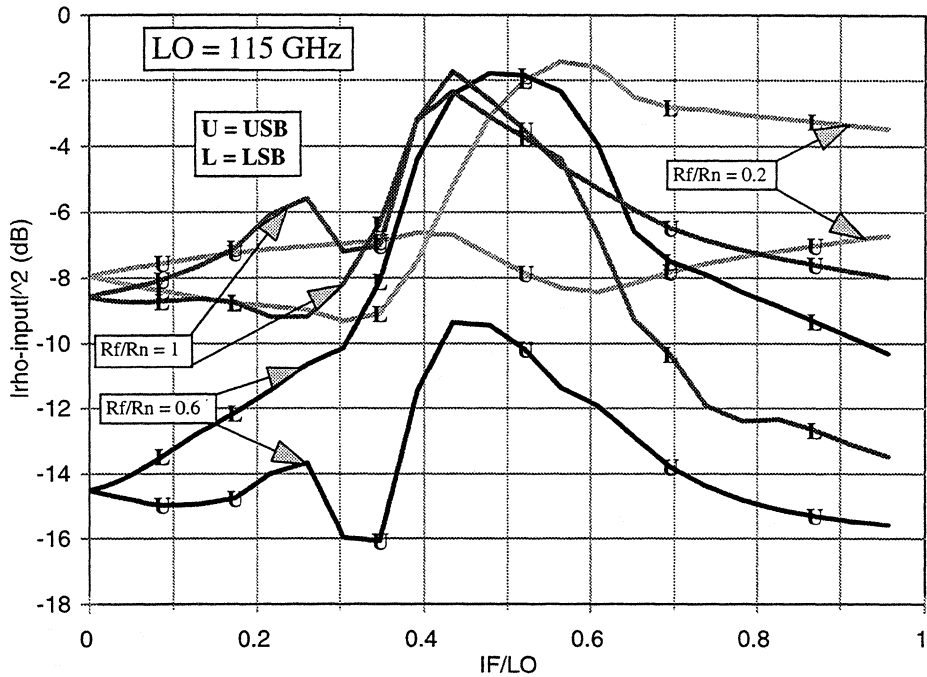

Fig. 5(a). Upper and lower sideband input match ( $|\rho_{\text{input}}|^2$ ) as functions of  $\text{IF}/\text{LO}$  for a 115 GHz SIS mixer. Results are shown for  $R_{\text{RF}}/R_{\text{N}} = 0.2, 0.6$  and 1.

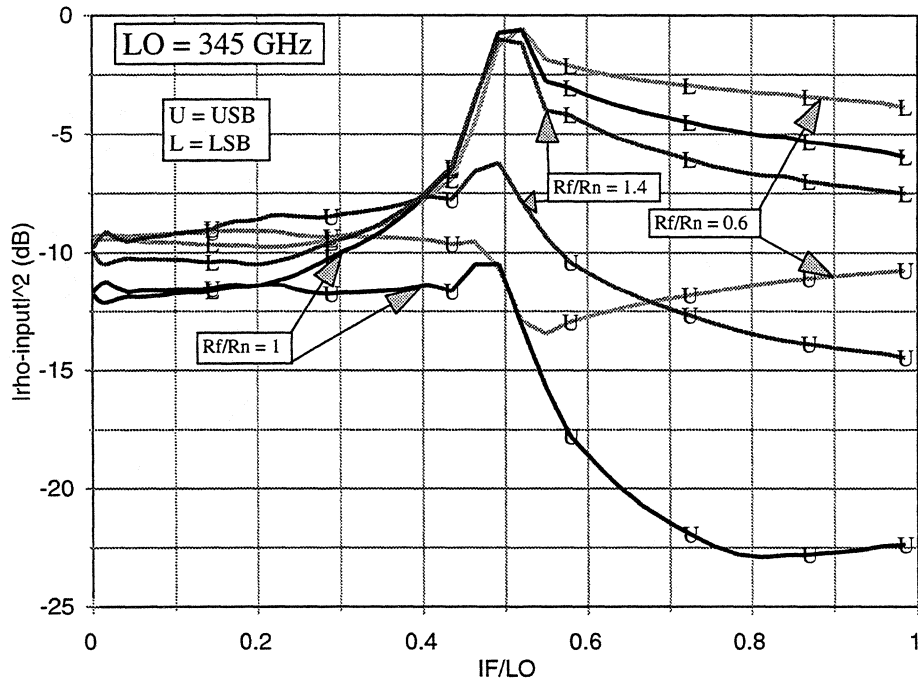

Fig. 5(b). Upper and lower sideband input match ( $|\rho_{\text{input}}|^2$ ) as functions of  $\text{IF}/\text{LO}$  for a 345 GHz SIS mixer. Results are shown for  $R_{\text{RF}}/R_{\text{N}} = 0.6, 1$  and 1.4.

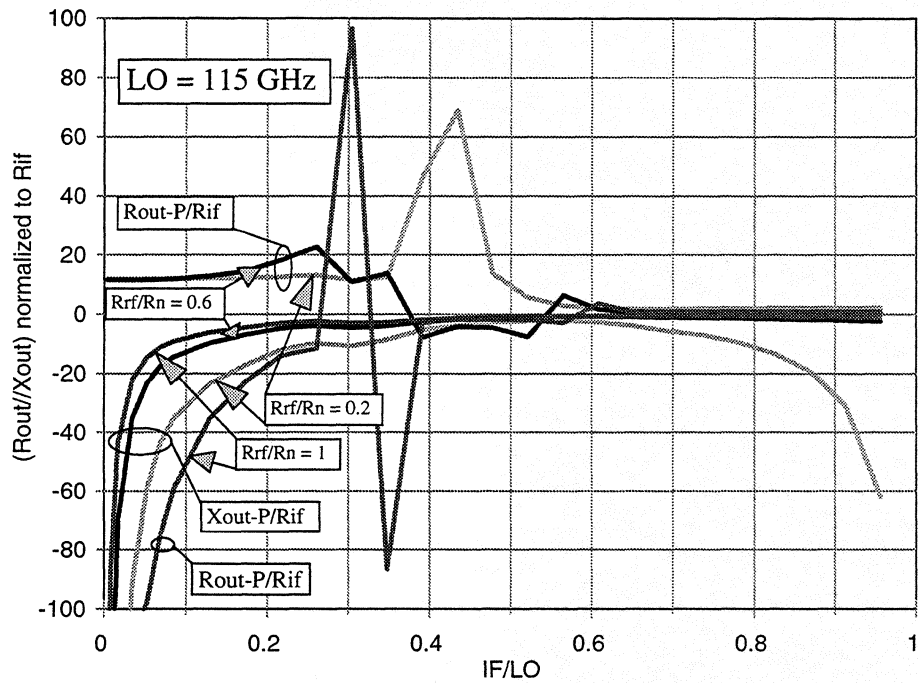

Fig. 6 (a). Normalized reciprocal output conductance and susceptance as functions of IF/LO for a 115 GHz SIS mixer. Results are shown for  $R_{RF}/R_N = 0.2, 0.6$  and 1.

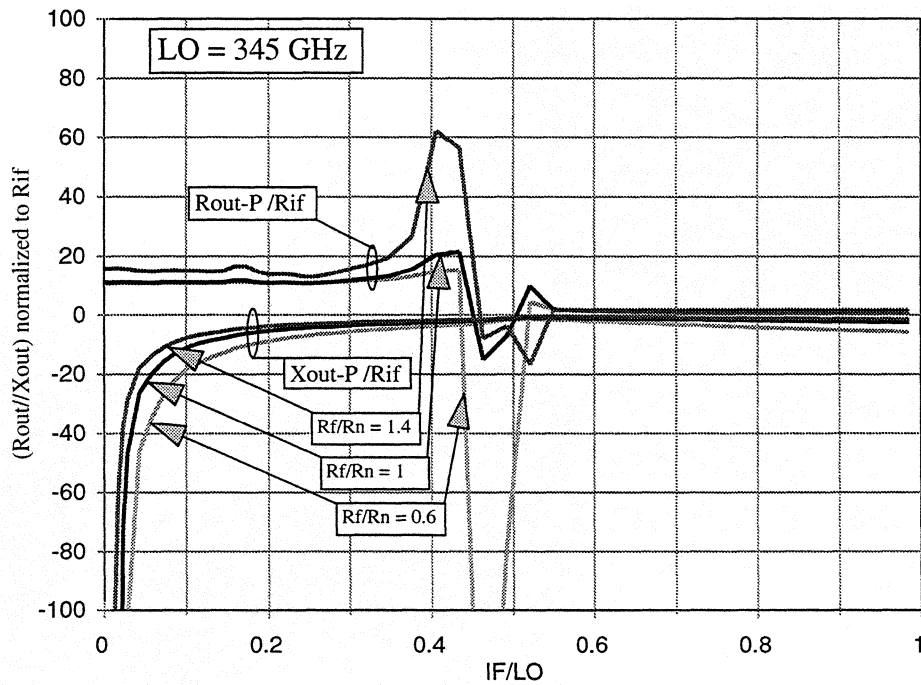

Fig. 6 (b). Normalized reciprocal output conductance and susceptance as functions of IF/LO for a 345 GHz SIS mixer. Results are shown for  $R_{RF}/R_N = 0.6, 1$  and 1.4.

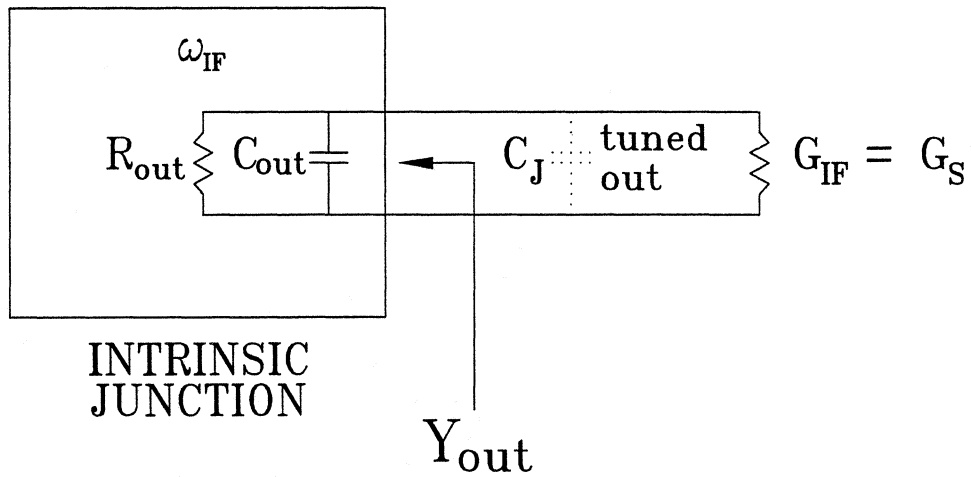

Fig. 7. The equivalent circuit of the mixer's output port. It is represented by a resistor whose value  $R_{out} = 1/G_{out}$  in parallel with a capacitor whose value is shown in Figs. 8(a)-(b).

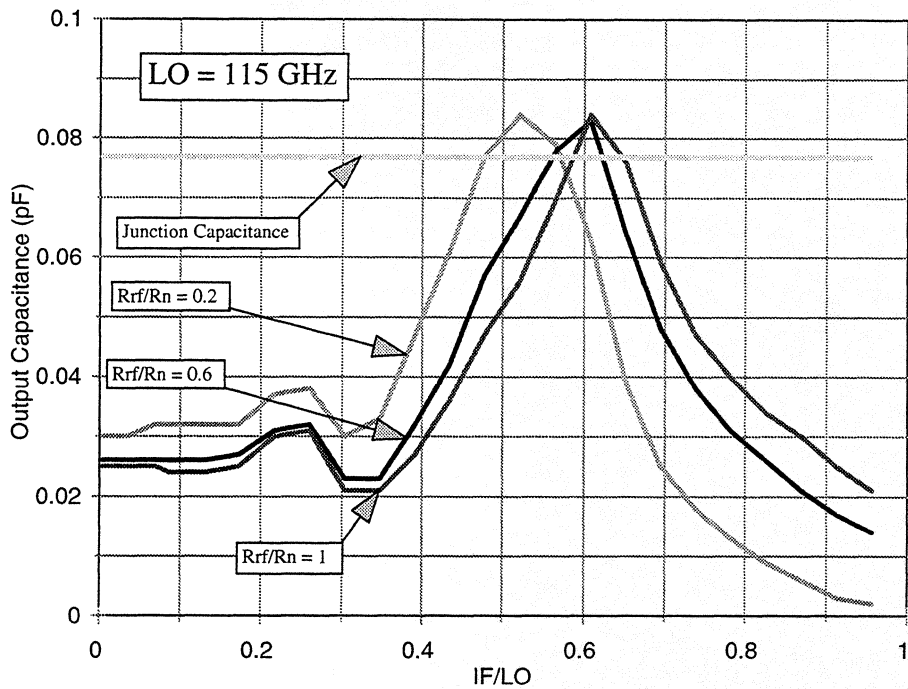

Fig. 8(a). Equivalent output capacitance as a function of IF/LO for a 115 GHz SIS mixer. Results are shown for  $R_{RF}/R_N = 0.2, 0.6$  and 1. Also shown is junction capacitance for comparison.

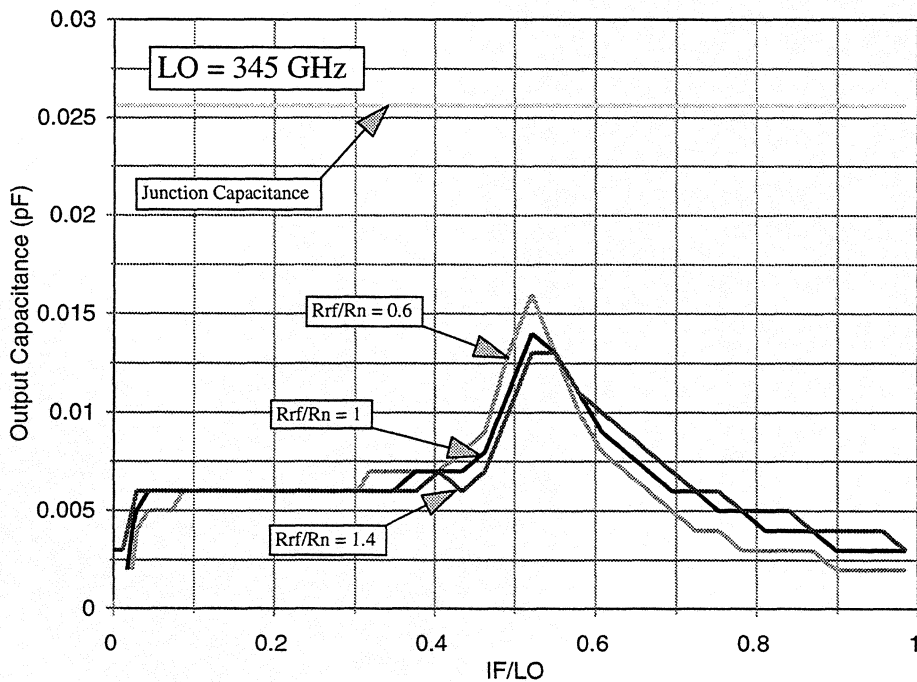

Fig. 8(b). Equivalent output capacitance as a function of IF/LO for a 345 GHz SIS mixer. Results are shown for  $R_{RF}/R_N = 0.6, 1$  and 1.4. Also shown is junction capacitance for comparison.