

A Closer Look at 2-Stage Digital Filtering in the Proposed WIDAR Correlator for the EVLA

NRC-EVLA Memo# 003

Brent Carlson, June 29, 2000

ABSTRACT

The proposed WIDAR correlator for the EVLA that is described in some detail in the first memo of this series uses digital filtering to provide a high degree of flexibility and performance for the end user of the EVLA. In that memo it was indicated that it may be useful to consider using 2-stage FIR filtering for increased performance in narrowband observing modes other than just for “radar mode”. Two-stage filters offer much sharper transition bands than single-stage filters using the same amount of hardware and therefore the performance and range of bandwidths that can be processed is increased. The penalty of course is that an extra quantization step is required. However, with 4-bit quantization this is an SNR penalty of only an extra $\sim 1.5\%$ —more than made up for with lower losses near the edge of the (sub-)band—resulting in an increase in the useable low-noise range of the band. This memo presents the results of several simulations that were done to quantify the performance and characteristics of the 2-stage filter. It also presents a refined FIR filter architecture that would provide programmable 1 or 2-stage capability and flexibility to allow it to be used as a general-purpose FIR filter for other 4-bit filtering applications.

Introduction

The proposed WIDAR correlator [1] [2] for the EVLA uses a bank of FIR filters to split the wide (2.048 GHz) baseband into sub-bands for subsequent efficient correlation. Using anti-aliasing and decorrelation techniques, the results are then stitched together to yield the wideband result. This technique has the additional benefit of providing improved spectral dynamic range in the presence of strong narrowband signals, greatly increased immunity to the modulating effects of time-variable interference, and the ability to perform completely digital sub-sample delay interpolation. The FIR filters are also useful for narrowband observing modes where increased spectral resolution is obtained over a narrower bandwidth. With a 1023-tap FIR filter, it is nominally feasible to use a bandpass as narrow as $1/256$ of the 2.048 GHz band resulting in a sub-band width of 8 MHz. In the proposed “radar mode”, each of the eight basebands would be equipped with an additional 2-stage filter allowing bandwidths as narrow as 30 kHz ($1/256 * 1/256$) to be generated. Using all correlator hardware without recirculation, this would provide for a spectral resolution of about 2 Hz. This memo proposes that all of the sub-band filters should have 2-stage capability resulting in increased performance and flexibility for the correlator. A potential FIR filter architecture is presented that would be



programmable for 1 or 2-stage capability as well as for other general purpose 4-bit filtering functions.

Two-Stage vs One-Stage Performance

A performance plot of a single-stage, 1023-tap 1/256 bandpass filter is shown in Figure 1.

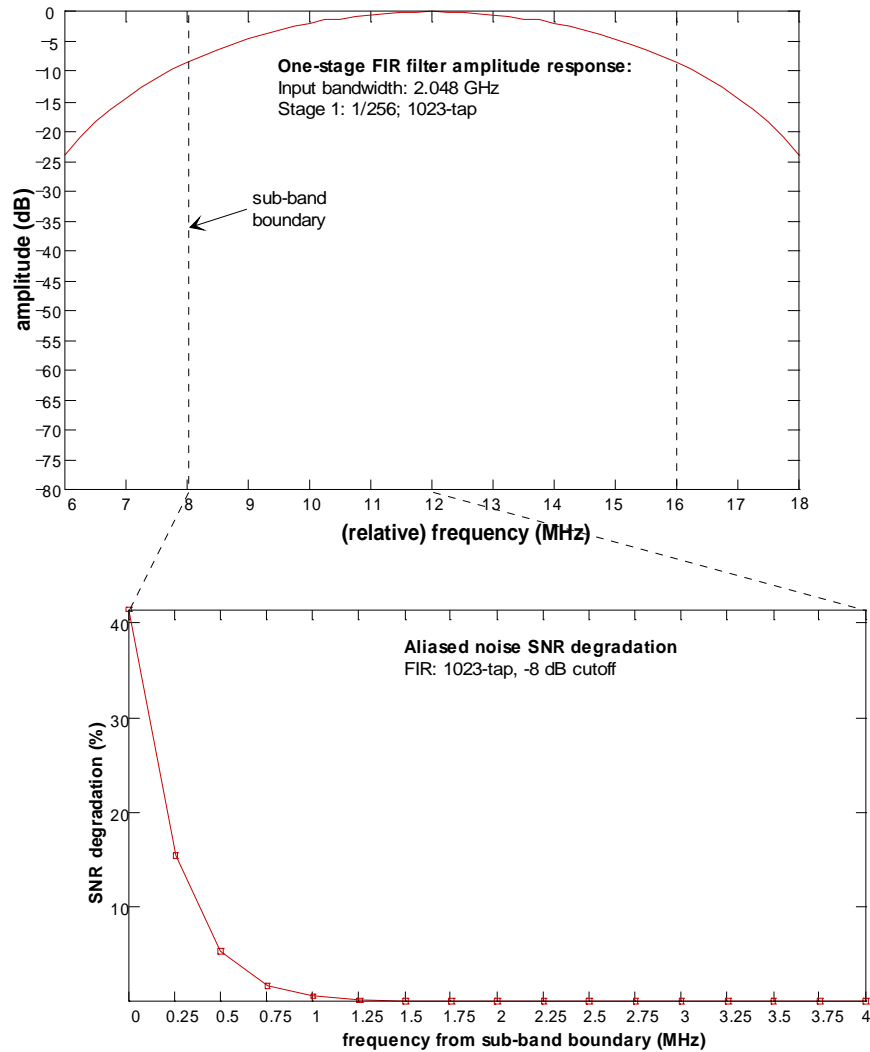

Figure 1 One-stage, 1/256 bandpass, 1023-tap FIR filter performance. The top plot shows the amplitude response across the sub-band and slightly outside the sub-band boundaries. The bottom plot shows the SNR degradation near the sub-band boundary resulting from transition band aliasing. Additionally, reject-band attenuation is about -40 dB.

Figure 2 is an example showing a wideband spectrum and the 1/256 “zoom” of a small part of the spectrum. The narrowband line is a sine wave and the spectrum has some structure to it so it can be visually determined if the correct part of the spectrum is being filtered and correlated (more clearly illustrated in Figure 4).

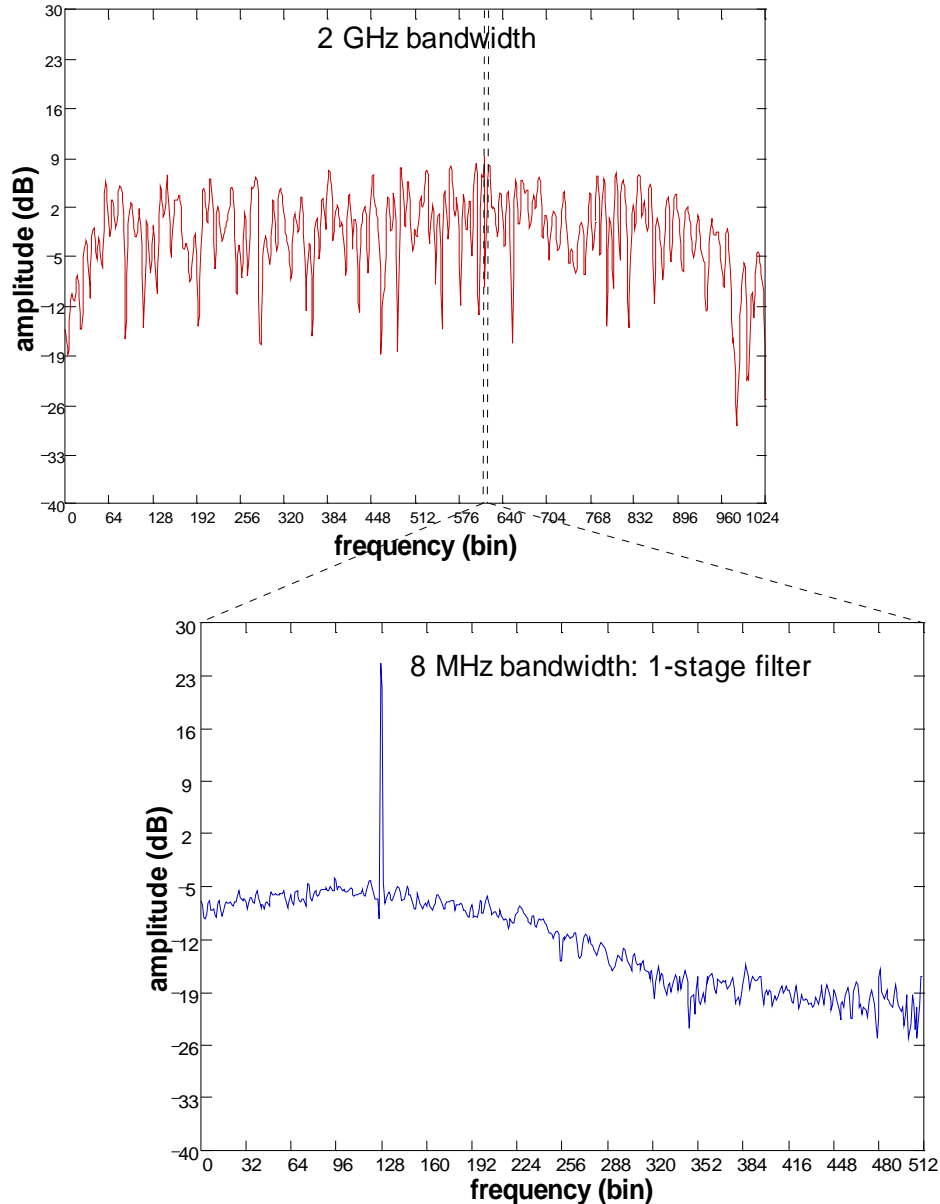

Figure 2 Simulation of 1/256 narrowband filtering and correlation of a spectrum with lots of structure and a narrowband line. The bandshape has not been corrected and the roll-off at the upper and lower edges of the band is evident (compare this to Figure 4).

In Figure 1, the top plot shows the in-band filter gain and transition band. Note that although the filter cutoff is about -8 dB (at the sub-band boundary), filter phase is well behaved well into this region [1]. The bottom plot shows the SNR degradation near the sub-band boundary. At about 275 kHz from the sub-band boundary, the SNR degradation is about 10%. However, at 250 kHz from the sub-band boundary, the degradation is starting to become excessive at $>20\%$. This means that about 6% of the band has its SNR degraded an excessive amount. Perhaps more importantly however, is the distortion that such a bandpass could have on windowed narrowband lines that would be in the output spectrum. If the narrowband lines in the bandpass are strong enough,

windowing (either in the lag domain or the frequency domain) must be performed *before* band shape correction to prevent sidelobe-generated distortion. If the bandpass is not flat, or at least close to being flat, the final result will be distorted compared to what it should have been since windowing is a function of the band shape *and* the data.

A performance plot of a two-stage filter is shown in Figure 3. Each stage performs 1/16 bandpass filtering followed by decimation for a total filter bandwidth of 1/256. This response is if the 2nd stage filtering is not near the edge of the 1st stage bandpass. If it is near the edge then the cutoff at one edge would be -2.4 dB. The SNR performance would also be worse than shown since the 2nd stage would be in the SNR degraded region of the 1st stage filter (in which case a single stage should be used).

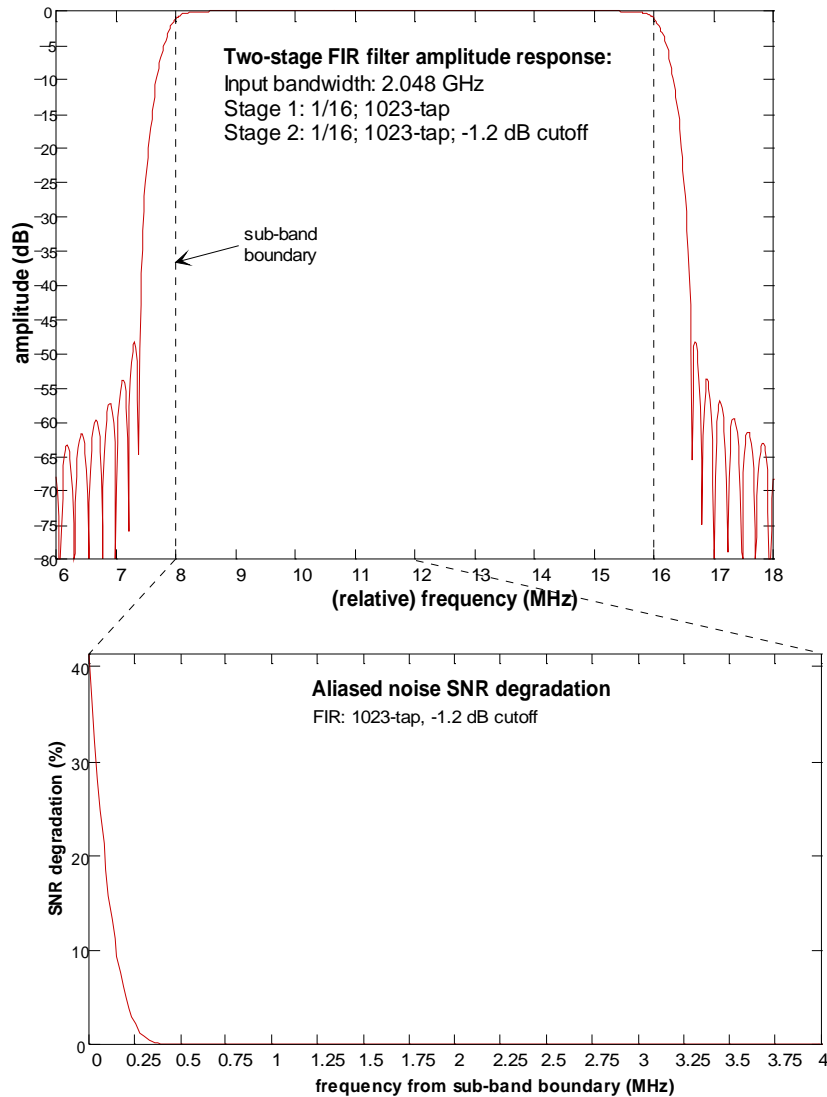

Figure 3 Two-stage filter performance with each stage performing a 1/16 bandpass using 1023-tap FIR filters. The top plot shows the amplitude response within the sub-band and just outside the sub-band boundaries. The filter has a -1.2 dB cutoff for very flat behaviour in the passband. The bottom plot shows the SNR degradation.

Figure 4 is a 2-stage simulation using the same wideband signal shown in Figure 2. For clarity, the cross-power spectrum of the 1st stage output is also shown.

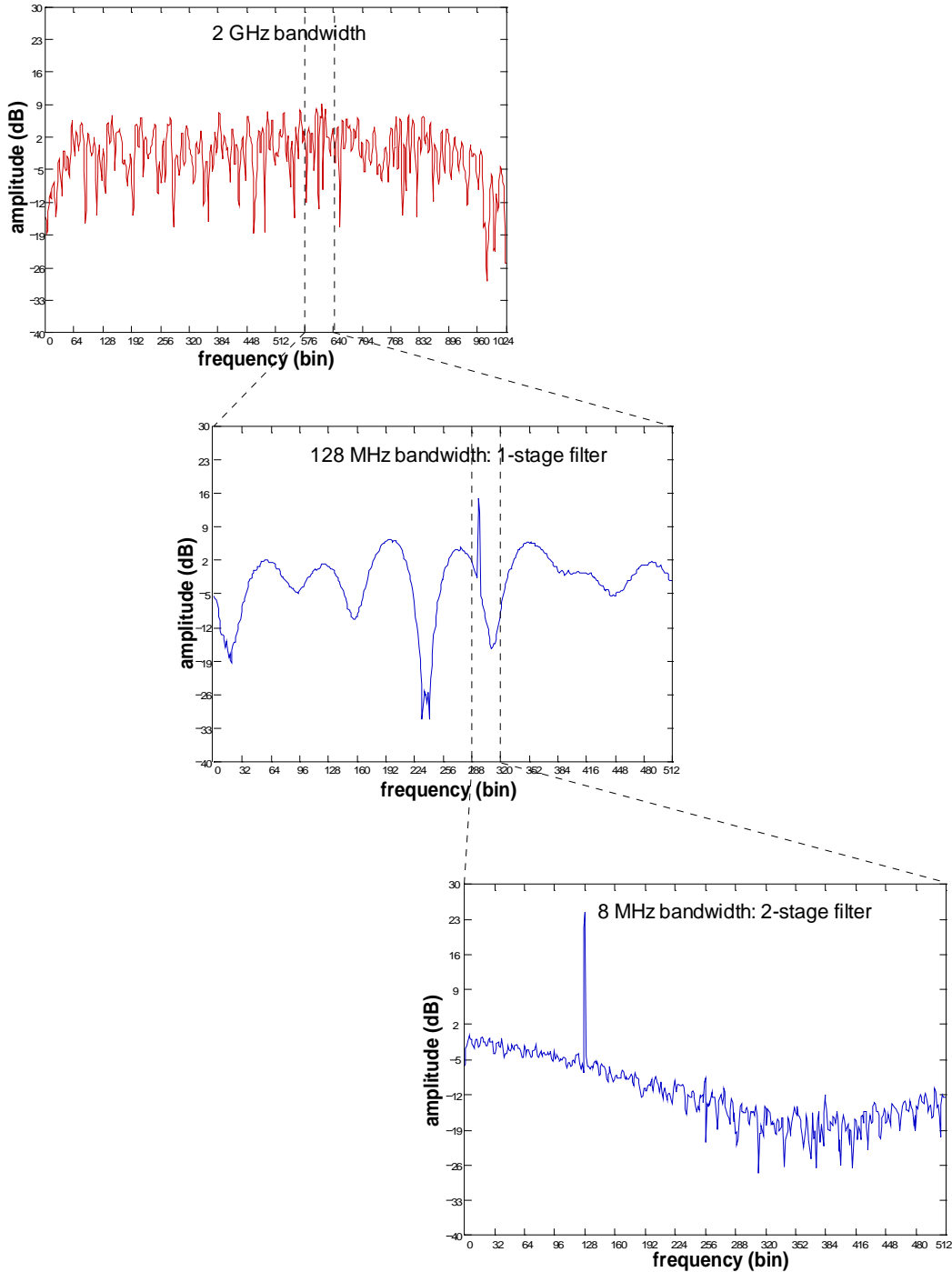

Figure 4 Simulation of 2-stage filtering with 1/16 bandpass filters used in each stage. The bandpass is much flatter than the single stage filter—evidenced by the lack of roll-off in the upper and lower parts of the bottom spectrum.

Two-Stage Radar Mode Performance

A 2-stage filter is required for narrowband radar mode. In this mode, about 30 kHz of bandwidth¹ is correlated with a spectral resolution of about 1 Hz. Because of this narrow bandwidth and with the use of Local Oscillator adjustment, it should be possible to place the signal in the middle of each stage's filter to avoid SNR degradation away from the middle. To achieve 30 kHz bandwidth from an original 2.048 GHz baseband sampled signal requires each stage to have a bandpass of 1/256. With 1023-taps in each stage, the final performance of the filter will be as shown in Figure 1 except that the final sub-band bandwidth will be 31.25 kHz. The cross-power spectrum of a simulation of a broadband spectrum containing a strong narrowband signal is shown in Figure 5. The roll-off due to the filter is evident. Provided the narrowband signal is near the center of the passband, the maximum SNR degradation will be about 6.5% (three 4-bit quantization steps and 5-level fringe rotation loss) and the distortion from windowing will be negligible. In order to keep the signals from shifting out of the band, it is necessary to limit the Local Oscillator offset² in each antenna to about 100 Hz—limiting the minimum integration time to about 100 milliseconds.

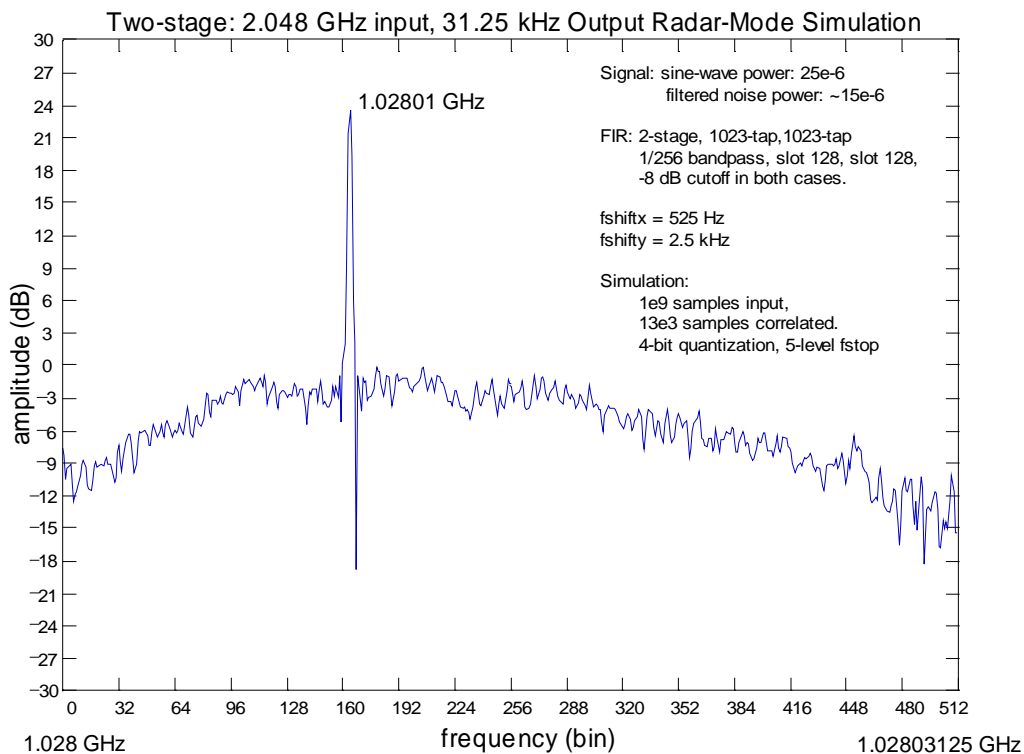

Figure 5 Simulation results with 2-stage filtering where each filter is 1/256 bandpass. The input bandwidth is 2.048 GHz and the output bandwidth is 31.25 kHz. Provided the narrowband signal is near the center of each filter's passband (or at least well enough away from the edge—see Figure 1), the total SNR degradation for a 4-bit system including fringe rotation loss is 6.5%.

¹ Wider bands with recirculation could be used to achieve the 1 Hz spectral resolution but it is valuable to achieve close to the 1 Hz resolution without the use of recirculation since recirculation has some integration time limitations [1].

² It is still necessary to use LO offsets so the digital fine delay tracking can be performed.

Possible FIR Filter Architecture

Figure 6 is a block diagram of a possible programmable 1 or 2-stage FIR filter that is capable of providing the performance outlined in previous sections. If each stage is 1024 taps, then the single stage performance will be better than shown in Figure 1.

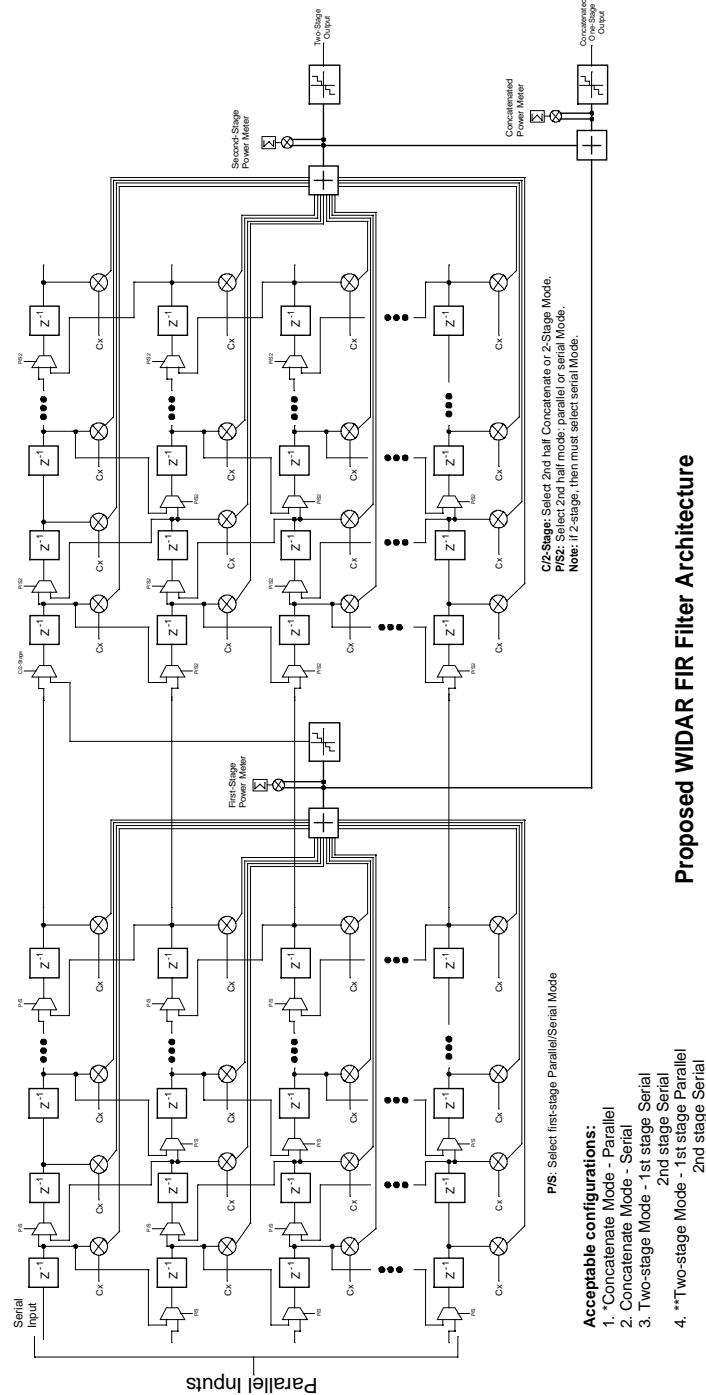

Figure 6 Proposed FIR filter architecture with programmable 1 or 2-stage operation with parallel or serial data flows. This filter can also be used for other lower-bandwidth 4-bit filtering functions because of its serial capability.

At 1024 taps per stage, the architecture shown in Figure 6 may be beyond the capability of a custom gate array and a full custom device may be required. If a full custom device is too expensive, then the number of taps in each section can be reduced and the “special-purpose” radar mode filter [1] will have to use two or more devices.

Figure 7 is a series of block diagrams that indicates the data flows for each possible filter configuration: **1. One-stage concatenate parallel**; **2. One-stage concatenate serial**; **3. Two-stage serial/serial**; **4. Two-stage parallel/serial**.

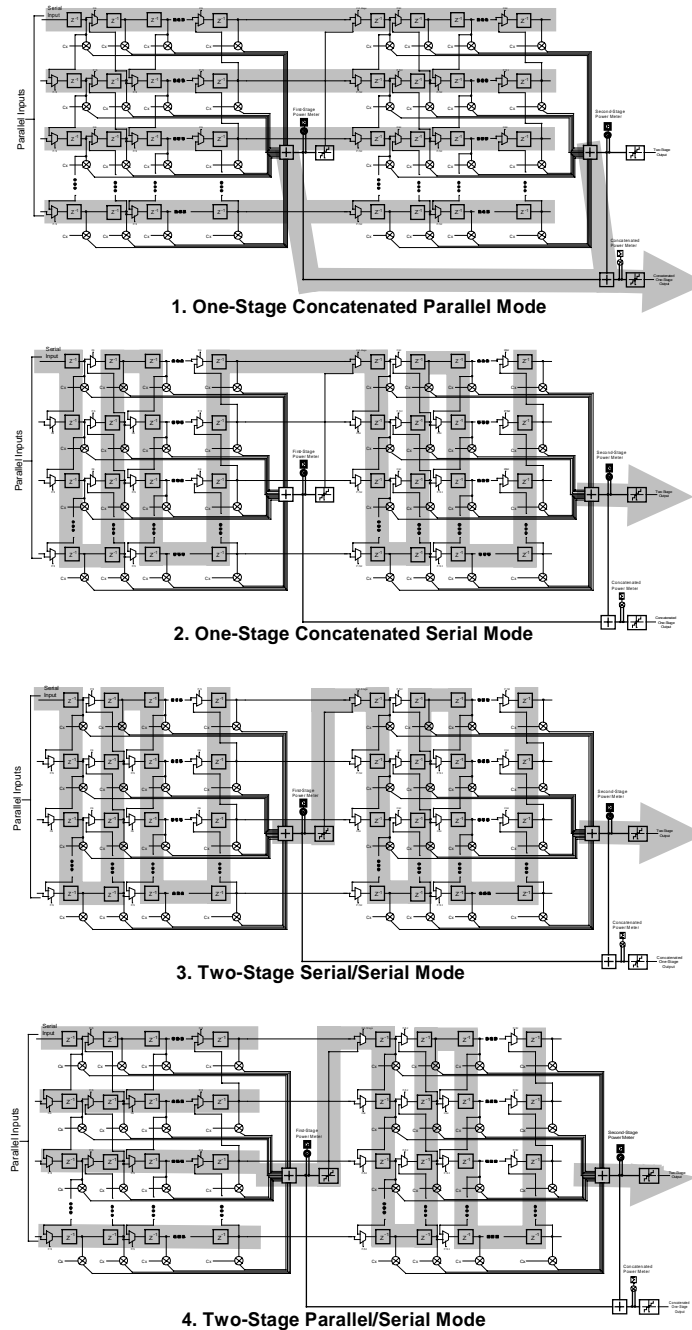

Figure 7 Proposed programmable FIR filter configurations. The correlator would normally use modes **1.** and **4.** Modes **2.** and **3.** are for more general purpose filtering applications.

Two-Stage Filtering Data Normalization

Normalized correlation coefficients (ρ) that are produced by a correlator are largely independent of the gain of any amplifier in the system. ρ depends only on the ratio of noise from the radio source to total noise including any added system noise [3] or quantization noise. For two-stage filtering, this means that the gain of the 1st stage digital filter is irrelevant. The normalization equation and methods developed in [1] can be used provided FIR filter output powers for stage 2 are used instead of from stage 1 and provided that within a given normalization, only the data within the same stage 1 sub-band is used³. For example, to correct the level of a stage 2 sub-band cross-power spectrum so that it is immune to some time variable interference that is within it, some FIR filter output power before requantization for a stage 2 sub-band that does not contain any narrowband signals must be obtained. This “reference” stage 2 sub-band must be within the same stage 1 sub-band as the stage 2 sub-band with the interference. This principle is illustrated with simulation results shown in Figure 8.

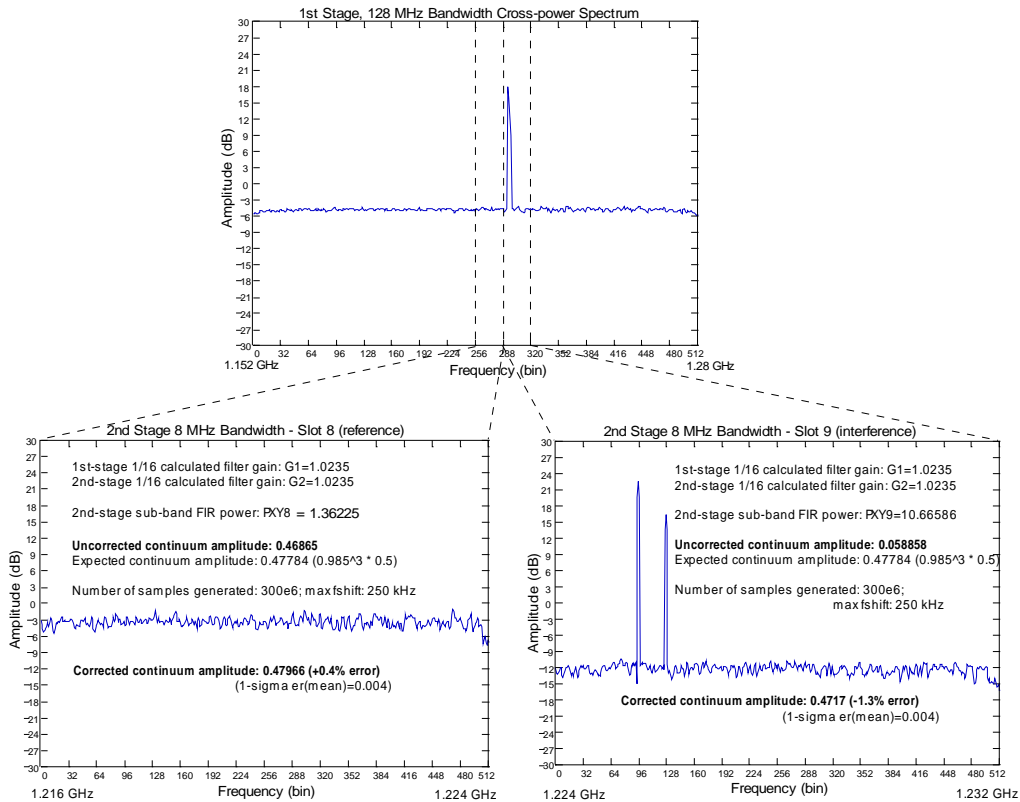

Figure 8 Plot showing the results of 2-stage correlation with and without narrowband signals. The top plot is a single stage correlation, the bottom left plot is the reference 2-stage correlation with no narrowband signals, and the bottom right is the 2-stage correlation with narrowband signals present. The continuum amplitude of the 2-stage correlation with narrowband signals is established to within -1.3 % of the expected level. The negative error is (presumably) due to higher quantization noise from the powerful narrowband signals although it is not entirely certain if this is the cause since the result is within $\sim 1.5\sigma$ ($\sigma=0.004$) of the expected value.

³ It is also important that the FIR output level for both stage 2 sub-bands is the same when there is no narrowband signal present (i.e. the band, or equalized band is flat).

Conclusions

A number of simulations were performed to quantify the performance advantage of using 2-stage filtering versus 1-stage filtering for narrowband high spectral resolution correlation. For narrow bands, 2-stage filtering offers a flatter bandpass response and sharper transition bands resulting in improved SNR near the sub-band boundaries and lower narrowband signal distortion if windowing is used. The penalty for 2-stage filtering is an additional quantization step which, for 4-bit quantization, results in an additional sensitivity loss of ~1.5%. More SNR degradation will occur if the 2nd stage sub-band is one of the edge sub-bands of the 1st stage bandpass due to aliased noise from the 1st stage transition band. This special case may require using single stage filtering or modification of the 1st stage bandpass (from that shown) for best SNR performance. A FIR filter chip architecture with a programmable configuration was developed. This architecture supports 1 or 2-stage filtering, with parallel, serial, or mixed parallel/serial operation. Thus, it can be used for a WIDAR correlator, or for other general purpose 4-bit FIR filtering applications.

References

- [1] Carlson, Brent, A Proposed WIDAR Correlator for the Expansion Very Large Array Project: Discussion of Capabilities, Implementation, and Signal Processing, NRC-EVLA Memo# 001, May 18, 2000.
- [2] Carlson, B.R., Dewdney, P.E., Efficient wideband digital correlation, *Electronics Letters*, IEE, Vol. 36 No. 11, p987, 25th May, 2000
- [3] Thompson, A.R., Moran, J.M. & Swenson, G.W., 1986, *Interferometry and Synthesis in Radio Astronomy*, Wiley, New York.

