

**Two Correlators for the Price of One:  
How a VLBA Correlator Could Fit Within the  
Proposed 40-Station WIDAR EVLA Correlator**

*NRC-EVLA Memo# 006*

Brent Carlson, September 28, 2000

**ABSTRACT**

The proposed 40-station WIDAR EVLA correlator [1] uses a novel technique for efficient wideband correlation. This technique requires the correlator to be capable of fringe stopping and as such, it is fundamentally capable of operating as a VLBI correlator. NRC has made the commitment [2] to design the Baseline Board for VLBI compatibility and will endeavour to design the Station Board so that the installation of a tape interface daughter board (or some equivalent) would allow VLBI operation. This memo explores how a VLBA correlator could fit within the planned 40-station correlator if the entire 40 stations are not required for EVLA operation. The size of the VLBA correlator, of course, depends on the number of unpopulated correlator station inputs. Some gain in station capability is made if the additional VLBA antennas require only 4 GHz of total bandwidth each—every unused correlator station input can handle two VLBA antennas. Additional gain is made if the required VLBA antenna bandwidth is reduced to 1 GHz—in this case every unused correlator station input can handle four VLBA antennas. Decent spectral-line capability will be available, with 512 frequency points per sub-band in wideband modes. Increased spectral resolution for line observations can be obtained by reducing the number of sub-bands and/or sub-band bandwidth. Finally, this memo shows that with some small correlator chip routing modifications, VLBA antennas can operate and correlate with EVLA antennas in real-time.

## 1 Introduction

The proposed 40-station WIDAR EVLA correlator [1] contains two essential elements relevant to this memo—the Station Board and the Baseline Board. The Station Board is capable of processing two, 2 GHz basebands. Data enters the Station Board via a daughter module that, for the EVLA, accepts data from two fiber-optic interfaces<sup>1</sup>—one for each baseband. Each baseband has its own completely independent delay model and thus can be on a different phase-center on the sky. Each 2 GHz baseband is split into 16

---

<sup>1</sup> The actual number of fibers coming into the board may be more, but conceptually there is one interface for each baseband.



sub-bands with digital filters on the Station Board. Each sub-band can be any bandwidth in decreasing powers of 2 from 128 MHz down. The minimum width of each sub-band is determined by the size of the digital filters and normally can be as narrow as a few hundred kHz<sup>2</sup>. Four Station Boards are used in parallel to provide 16 GHz of total bandwidth from each EVLA antenna (i.e. 8 basebands or 4 baseband pairs). The four Station Boards plug into the “Sub-band Distributor Backplane”, and there are 16 cable outputs from this backplane<sup>3</sup>. Each of these 16 cables contains data for all 8 basebands of one sub-band. Each cable goes to a separate “sub-band correlator” and each sub-band correlator correlates the data for one sub-band from all antennas. Each sub-band correlator contains several Baseline Boards (15 for a 40-station correlator) and data on the input cables gets distributed to Baseline Board inputs via one “Station Data Fanout Board” per antenna (per sub-band correlator). The Baseline Board has 8 ‘X’ inputs and 8 ‘Y’ inputs and can correlate all baselines for an 8 x 8 parallelogram of the baseline matrix (see Figure 1). Each of the 64 correlations in the 8 x 8 matrix is performed with one correlator chip on the Baseline Board.

This memo will show that if an antenna only has 4 GHz total bandwidth (two 2 GHz basebands), then only one Station Board is required for the antenna. Each input to the Baseline Board can then be arranged so that it actually contains data from two antennas and each correlator chip correlates the data for four baselines. With small routing additions to the correlator chip, it is possible to correlate 4 GHz antennas with 16 GHz antennas when the 16 GHz antennas are using their full bandwidth. All of this capability can be provided within the normal station-to-baseline wiring of the full 16 GHz correlator. Additionally, another dimension is explored whereby four, 1 GHz antennas can be correlated for every unused (16 GHz) station input in the correlator.

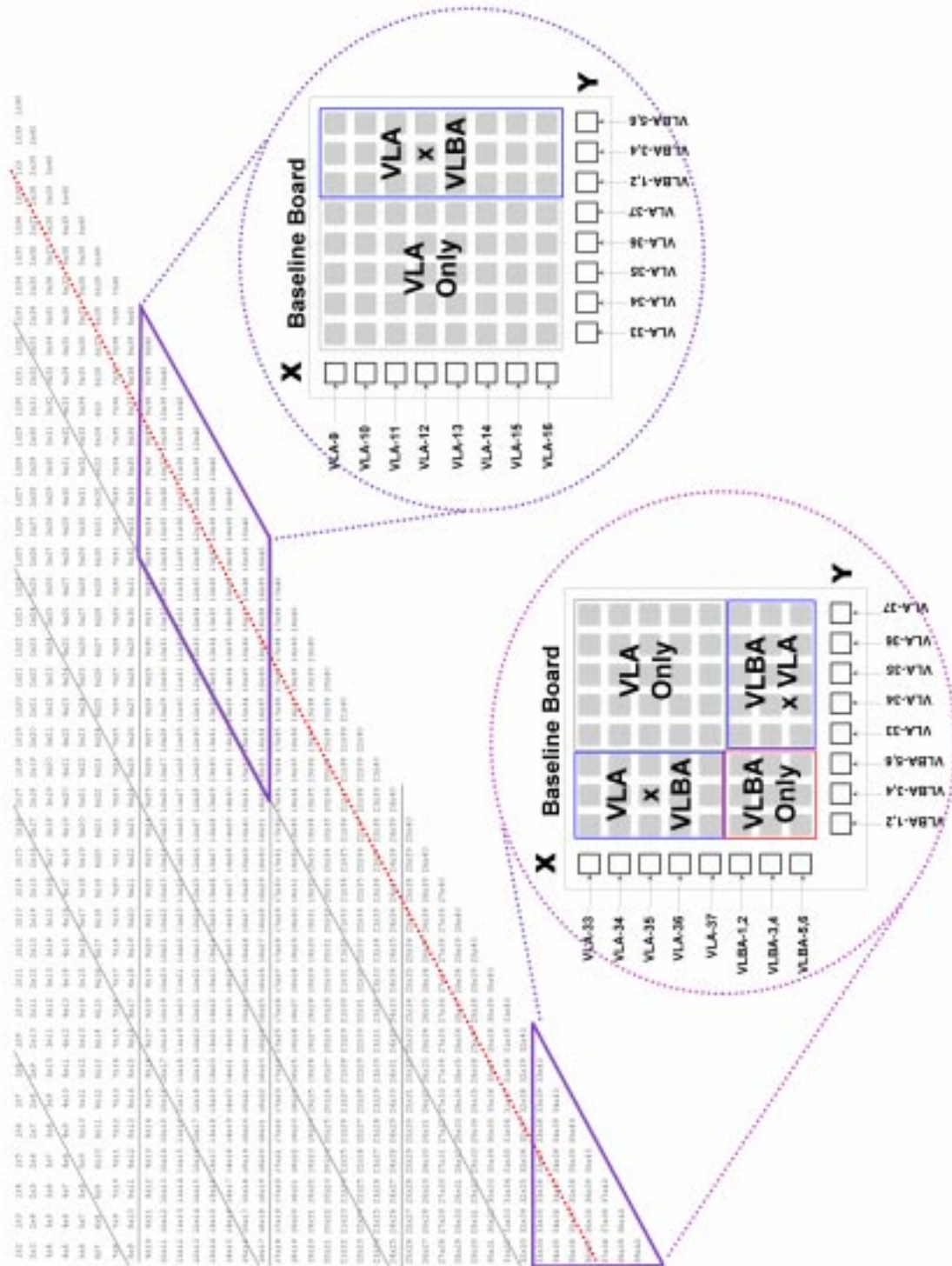
## 2 Correlator Baseline Matrix Layout

Figure 1 shows a 40-station baseline matrix with an *example* 6-station, integrated 4 GHz (VLBA) correlator. Each Baseline Board correlates data (for one sub-band) for one 8 x 8 parallelogram (an example of which is highlighted in the figure) or an edge triangle. The figure shows an array of 64 correlator chips on the Baseline Board. Normally, each correlator chip performs all of the correlations for one baseline and one sub-band of 8 basebands (or 4 baseband pairs). However, if a station has only 4 GHz of total bandwidth, then each correlator chip does 4 baselines with two basebands.

The VLBA-only correlations are performed in the bottom left triangle with the layout of the associated Baseline Board as shown. The board also performs 16 GHz correlations (VLA only) and 4 GHz x 16 GHz correlations (VLA x VLBA or VLBA x VLA). The highlighted parallelogram and associated Baseline Board layout shows how other VLA-only and VLA x VLBA correlations are performed along the matrix diagonal.

<sup>2</sup> Except for the “radar-mode” filter which can be narrower.

<sup>3</sup> ...for correlation—more outputs are required for going to the phasing subsystem.

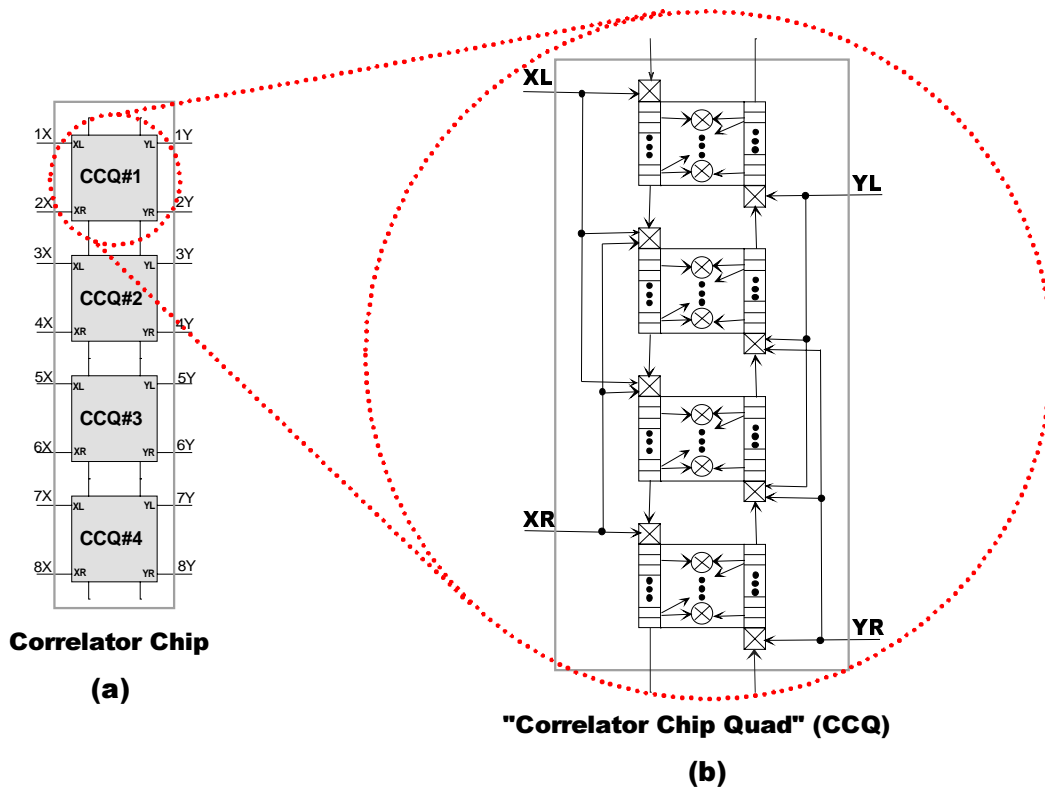


**Figure 1** 40-station baseline matrix example showing where three of the 16 GHz (VLA) stations are used instead for a 6-station, 4 GHz (VLBA) correlator. The highlighted triangle is where the VLBAxVLBA and VLBAxVLA correlations are performed. The highlighted parallelogram is one part of the matrix where only VLAxVLA and VLAxVLA correlations are done.



### 3 Correlator Chip Architecture and Data Routing

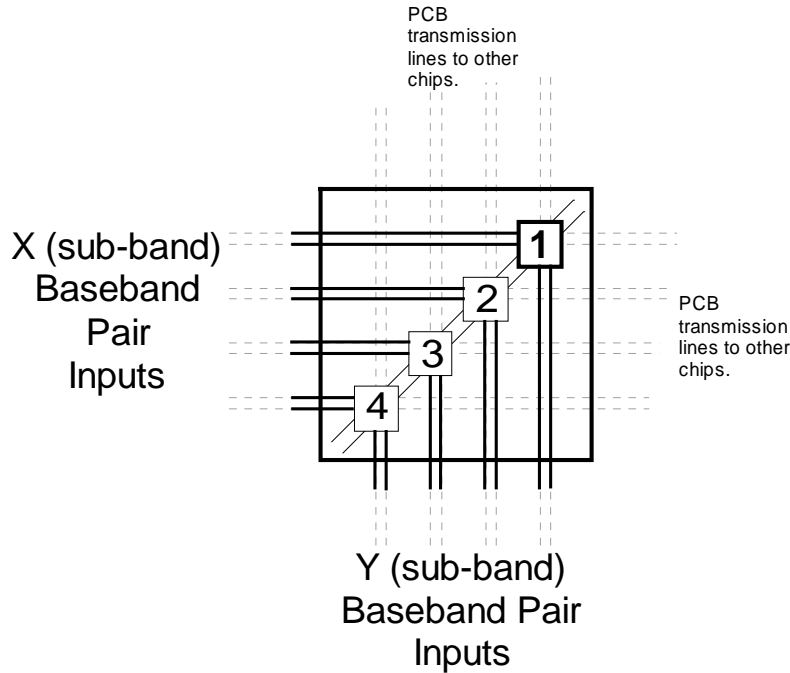
Figure 1 shows generally how 4 GHz antennas fit within the infrastructure of a 40-station correlator. However, in order to determine what additional hardware routing resources are required, it is necessary to take a detailed look at data routing on the Baseline Board and on the correlator chip. Figure 2 is a functional block diagram of the correlator chip showing data<sup>4</sup> routing paths, and correlator lags. (Not shown are the blocks necessary for VLBI mode that calculate the vernier delay and phase modifier [3] and apply the results in the data and phase paths.) Figure 2 (a) is an overall block diagram of the correlator chip. The chip contains 4 “Correlator Chip Quads” (“CCQs”). Each CCQ contains 4, 128-lag cross-correlators (Figure 2 (b)) and each cross-correlator performs ‘lag’ and ‘lead’ correlation functions. It is possible to concatenate 128-lag cross-correlators, and CCQs within a correlator chip can also be concatenated. Thus, a correlator chip can perform as many as 16 independent 128-lag cross-correlations, or as few as one 2048-lag cross-correlation.



**Figure 2** Correlator chip functional block diagram showing data routing paths. In (a) an overall diagram of the chip is shown. The chip contains 4 “Correlator Chip Quads” (CCQs)—each one containing 4, 128 complex-lag cross-correlators (b). The chip can accept data from up to 8 ‘X’ and ‘Y’ basebands or 4 baseband pairs (or any combinations thereof) and perform all necessary cross-correlations. Correlators within CCQs can be concatenated and CCQs within a correlator chip can be concatenated for longer lag chains on fewer basebands.

<sup>4</sup> Phase requires an identical routing path. For simplicity, one line in the figure represents data and phase.

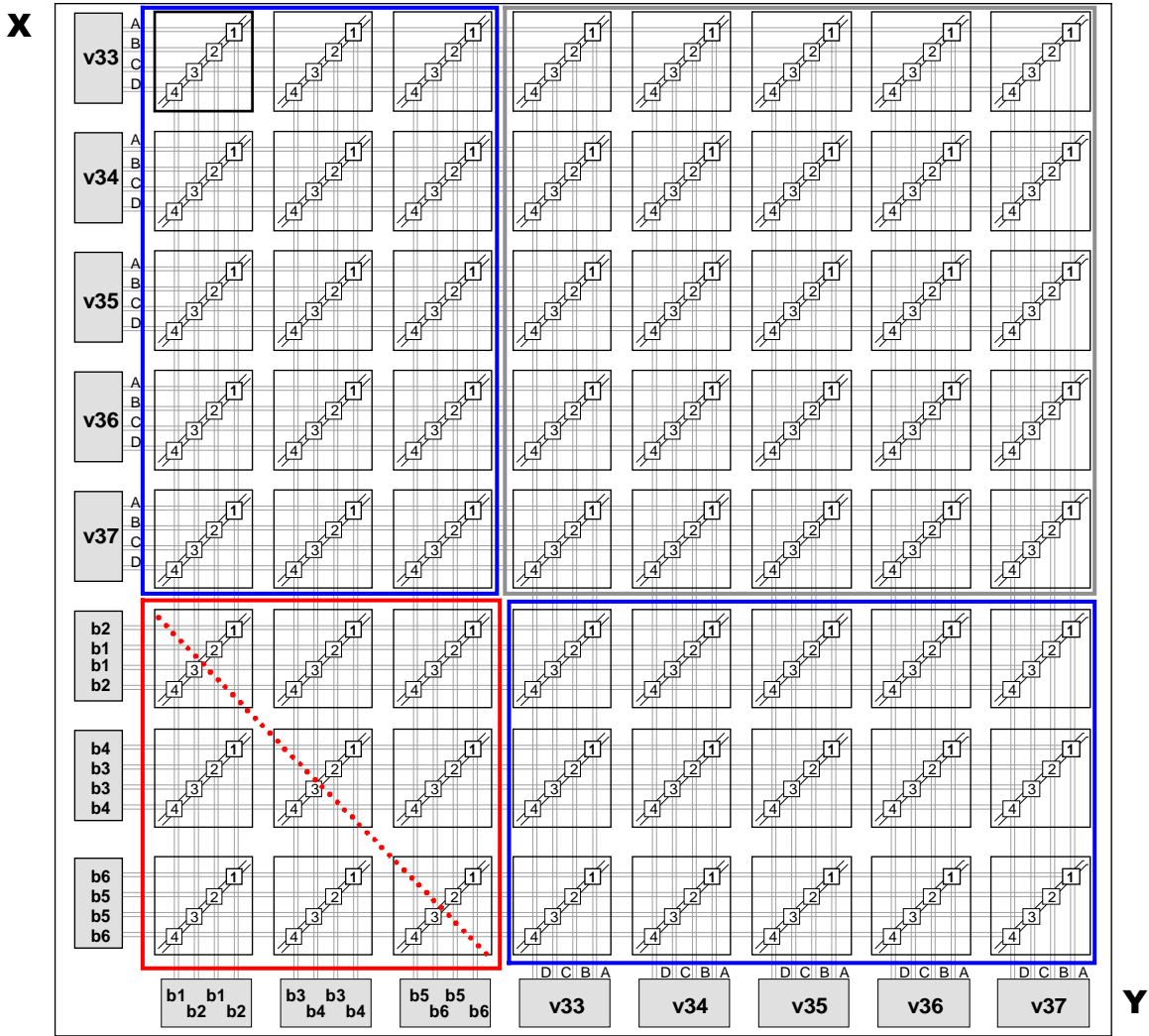
A simplified block diagram of the correlator chip that is useful for including in a block diagram of the entire Baseline Board is shown in Figure 3. The chip contains the 4 (numbered) CCQs, 8 ‘X’ and ‘Y’ baseband inputs, and CCQ-to-CCQ data routing paths. The diagram also shows where PCB (printed circuit board) data paths will go to connect to other correlator chips on the board.



**Figure 3** Simplified block diagram of the correlator chip that will be useful for including in a functional block diagram of the Baseline Board. Each chip contains 4 CCQs, 8 ‘X’ and ‘Y’ baseband inputs, and CCQ-to-CCQ data routing paths. PCB data paths to other correlator chips are also shown.

Figure 4 is a functional block diagram of a Baseline Board with X and Y input station assignments to correlate (one sub-band of) the highlighted triangle containing VLBA antennas shown in Figure 1. The ‘v\*’ inputs (e.g. ‘v33’) are 16 GHz VLA antenna inputs where all 4 baseband pairs could be active. The ‘b\*’ inputs (e.g. ‘b1’, ‘b2’) are 4 GHz VLBA antenna inputs where only one baseband pair from each antenna is active. The X and Y input boxes are FPGAs that receive and synchronize data coming from one sub-band cable from 4 Station Boards that make up a correlator station input. These FPGAs are capable of connecting any input baseband signal to any output baseband signal going to a row or column of correlator chips. The FPGAs also perform recirculation functions and are capable of inserting some delay into the baseband data paths before being transmitted to the correlator chips. Figure 4 makes use of the simplified correlator chip diagram shown in Figure 3 so that all data routing paths on the board and in the chip can be understood in detail. Figure 4 uses the same example as in Figure 1 where there are 37, 16 GHz VLA antennas, and three unused inputs that can be used for six, 4 GHz VLBA antennas<sup>5</sup>.

<sup>5</sup> Later, it will be shown that the three unused inputs can be used for 12, 1 GHz antennas or a combination of 1 GHz and 4 GHz antennas.



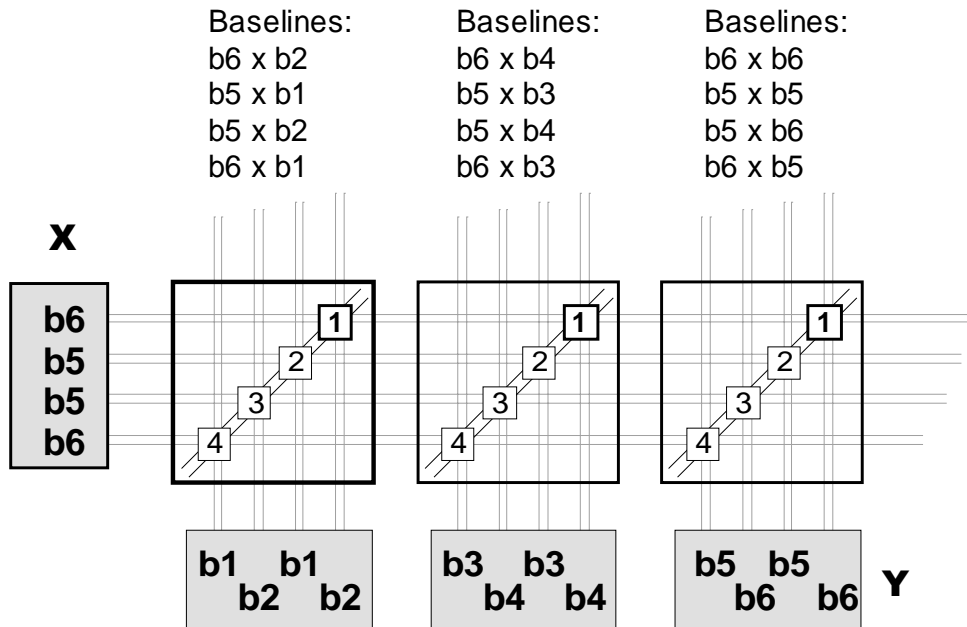
**Figure 4** Baseline Board block diagram showing in detail the VLA (‘v\*’) 16 GHz input, and the VLBA (‘b\*’) 4 GHz input receiver assignments for the highlighted triangle shown in Figure 1. The input receivers are FPGAs that allow any input baseband signal to be connected to any output baseband signal going to a row (X) or column (Y) of correlator chips. These FPGAs also perform recirculation functions and can insert delay into baseband data paths.

### 3.1 VLBA–Only (4 GHz) Correlations

Consider for now the lower left square of 9 correlator chips in Figure 4 where VLBA–only (4 GHz) cross-correlations are performed. The ‘X’ and ‘Y’ station assignments to baseband data paths are such that each correlator chip (in the bottom triangle of the square) can perform cross-correlations for 4 unique baselines—a 2 x 2 parallelogram—within the baseline matrix. Each CCQ on the correlator chip performs one baseline correlation and because there are 4, 128-lag cross-correlators in the CCQ, all polarization products can be obtained. The ‘X’ (e.g. “b6-b5-b5-b6”) and ‘Y’ (e.g. “b1-b2-b1-b2”) station assignments to FPGA baseband outputs are *required* to allow the necessary baseline correlations to be performed without requiring additional routing resources on



the circuit board, or the correlator chip. A close-up of a portion of this region on the Baseline Board is shown in Figure 5. The figure indicates which baselines are correlated in each correlator chip.



**Figure 5** Close up of VLBA-only cross-correlations showing the X and Y station assignments that allow 4 baselines (2 x 2 parallelogram) to be correlated without any additional routing resources on the correlator chip or the Baseline Board.

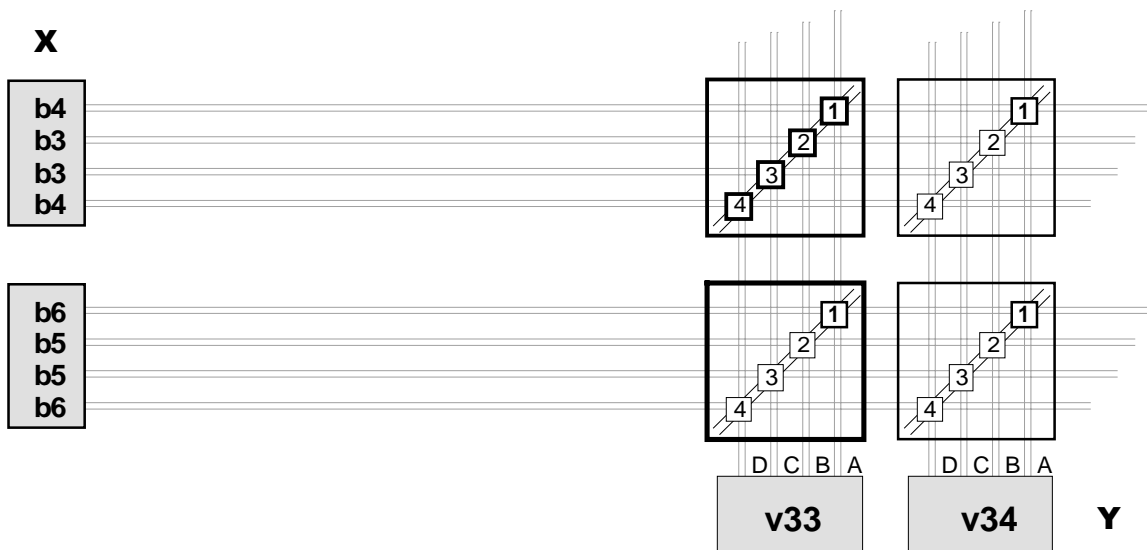
At first glance, the right-most correlator chip in Figure 5 would appear to be doing redundant correlations: it correlates **b5xb6 and b6xb5**. However, this can be used advantageously to double the spectral resolution from the VLBA-only portion of the correlator if a delay equal to a lag chain length is inserted into the data coming from the X station FPGA. In this case the correlations performed are **b5<sub>delay</sub>xb6 and b6<sub>delay</sub>xb5**. The first one, **b5<sub>delay</sub>xb6** correlates the first half of the lags and the second one **b6<sub>delay</sub>xb5** correlates the second half of the lags. The two separate correlations can be concatenated once a complex conjugate correction (flipping the sign of the imaginary component) is applied to one result since ‘X’ and ‘Y’ is swapped in the second correlation. Since only one side of the autocorrelator lags is required, the sub-band autocorrelation of **b5<sub>delay</sub>xb5** will yield the same number of spectral points as the dual cross-correlations just mentioned. It turns out that if the number of VLBA stations that need to be correlated can fit on one Baseline Board (for the sub-band), then spectral resolution doubling on VLBA-only baselines occurs. The dotted diagonal line in the VLBA-only portion of Figure 4 indicates the boundary where the ‘lag’ and ‘lead’ correlations are performed with this doubling method. However, it is not generally possible to get spectral doubling on VLBA-VLA correlations (e.g. highlighted parallelogram of Figure 1).

It is important to note that it is not necessary to have the 4 GHz of total bandwidth assigned to two 2 GHz basebands. If it is desired to have more basebands (or IFs) then it is possible provided that the total bandwidth is 4 GHz or less. In this case, each baseband

input to the Station Board contains the data from more than one sampled signal. For example, a Station Board baseband input could accommodate two 1 GHz basebands: 8 demultiplexed data streams contain the data for one baseband, and the other 8 demultiplexed data streams contain the data for the other baseband. Here, each 1 GHz baseband is sampled at 2 Gs/s and is demultiplexed by 8. These 8 streams are processed into 8 sub-bands by 8 FIR filters, but only 1/2 of each FIR filter's[4] taps are used—the other 1/2 are set to 0. Similarly for the other 1 GHz baseband. In this example it is possible to correlate 2 baseband pairs with one Station Board—useful for multi-frequency VLBA operation (C. Walker).

### 3.2 VLBA x VLA (4 GHz x 16 GHz) Correlations

If VLBA antennas are connected to the correlator in real-time, then it is most likely desirable to be able to correlate 4 GHz VLBA antennas with associated basebands of 16 GHz VLA antennas—*while VLA x VLA correlations are being performed at the full 16 GHz bandwidth*. As will be shown, this combination requires some additional routing resources on the correlator chip. Figure 6 is a close up of some VLBA x VLA observations on the Baseline Board of Figure 4 (the highlighted triangle of Figure 1). Here, baseband 'A' of the VLA antennas "v33" and "v34" is the baseband that was originally at the same sky frequency as the VLBA antennas and is the baseband we want to correlate. Since, in this case, we want the VLA antennas to be operating at the full bandwidth, it is not possible to replicate baseband 'A' to multiple outputs of the VLA 'Y' FPGAs since the other basebands would then be unusable. Thus, the additional routing must be performed on the correlator chip.



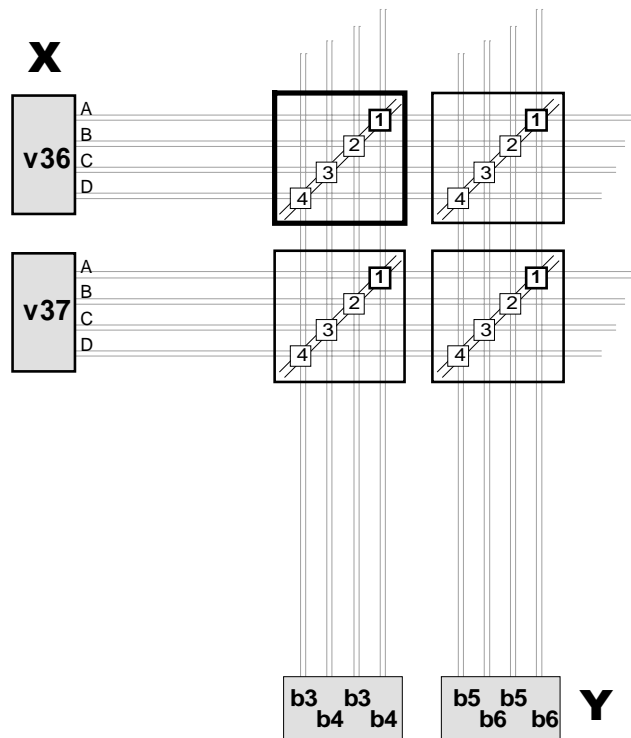
**Figure 6** Portion of the Baseline Board of Figure 4 where we want to perform VLBA x VLA correlations.

If VLA ('Y') baseband 'A' is copied from CCQ#1 to all of the CCQ inputs on the correlator chip, then it will be possible to perform all of the necessary correlations. This extra routing on the correlator chip should not add too much complexity or power dissipation to the device—highly desirable to minimize additional cost. For example, in



the bold highlighted correlator chip of Figure 6, CCQ#1 will do the **b6xv33-A** correlation, and CCQ#3 will do the **b5xv33-A** correlation. In this case CCQ#2 and CCQ#4 are not used—a waste of resources that can only be eliminated with more complex chip routing. (It is recognized that more general chip routing capability will allow all correlator chip resources to be used in the most efficient way possible. However, the goal here is to find the *minimum* extra correlator chip routing required to enable all necessary correlations to occur even if it is somewhat inefficient. If more general chip routing turns out to be inexpensive and low power at implementation time, it can easily be incorporated.)

Figure 7 is a diagram of a portion of the Baseline Board of Figure 4 where VLA x VLBA correlations are being performed. In this case CCQ#1 and CCQ#4 perform the correlations and CCQ#2 and CCQ#3 are unused.



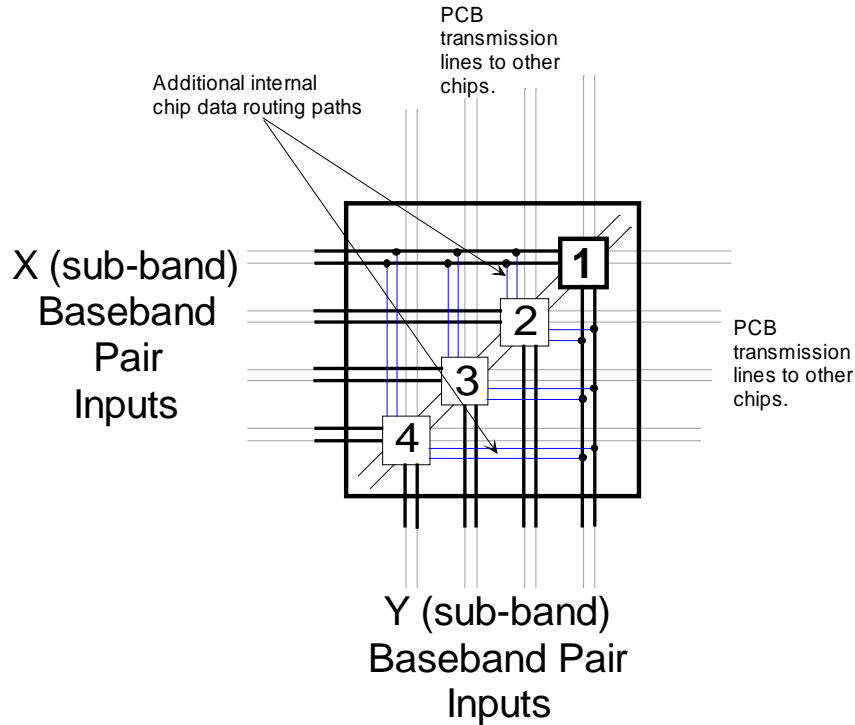
**Figure 7** Portion of the Baseline Board where VLA x VLBA antennas are being correlated. These are indeed redundant correlations with similar VLBA x VLA correlations, but “lag doubling” can be implemented by inserting appropriate delay in the X (or Y) station data paths. (However, this doubling can only be done in the highlighted triangle of Figure 1 and not in the highlighted parallelogram of Figure 1, so it may not be a useful feature.)

### 3.3 Modified Correlator Chip Architecture

The additional routing resources required on the correlator chip to allow VLA x VLBA (16 GHz x 4 GHz) correlations as described above are shown (blue-highlighted) in Figure 8. CCQs 2 through 4 require additional 2:1 selectors (each one being 8 bits wide) in front

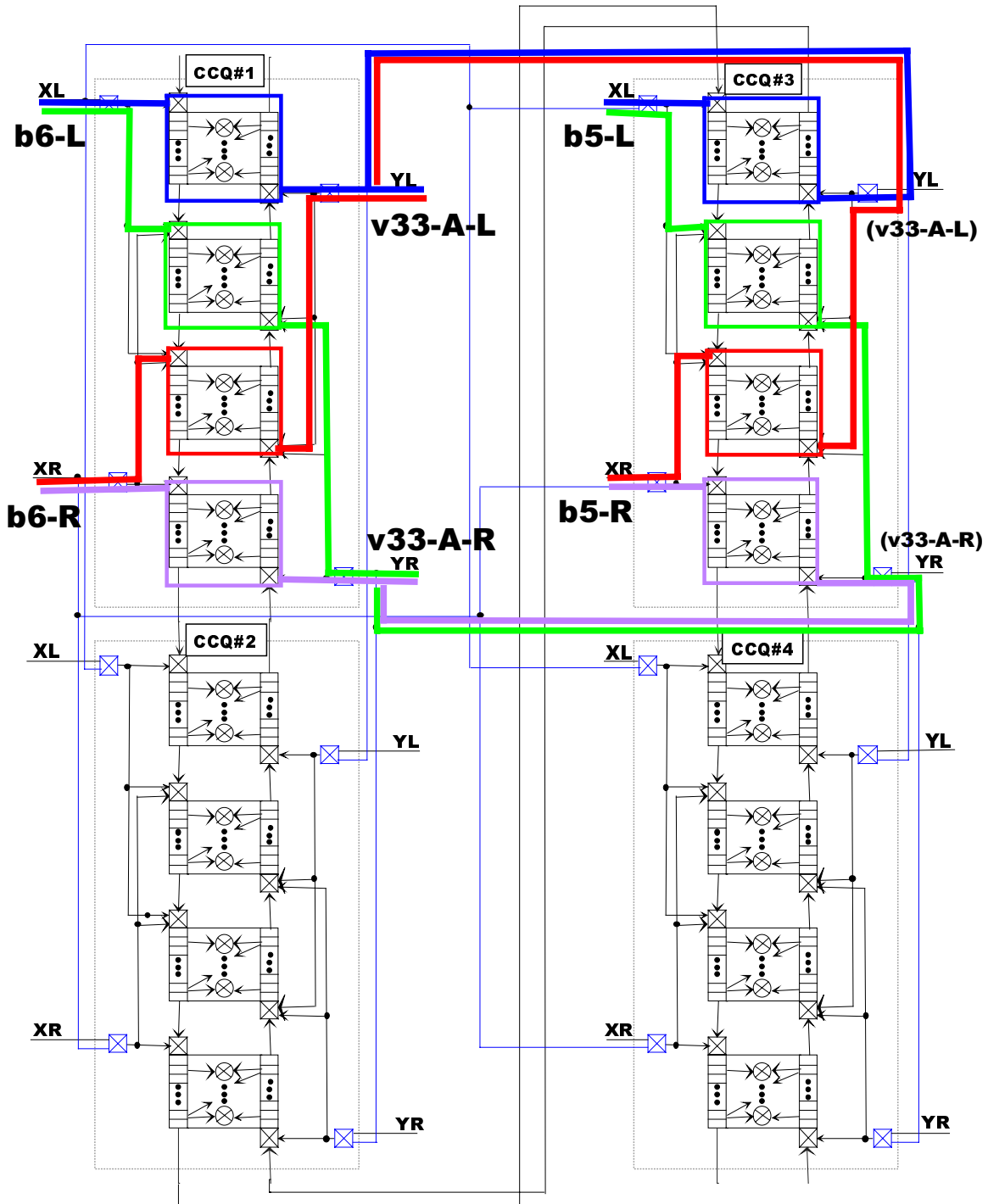


Figure 9 is a simplified correlator chip block diagram in the style of Figure 3 showing the additional routing paths.



**Figure 9** Simplified correlator chip block diagram showing the additional routing resources (highlighted in blue) required for VLA x VLBA and VLBA x VLA correlations.

Figures 10 through 15 are detailed correlator chip block diagrams showing the correlator chip data routing for VLBA x VLA correlations and VLA x VLBA correlations with four, two, and one polarization products respectively. The two polarization products case is either two polarizations of 2 GHz each or one polarization, two basebands of 2 GHz each for a total 4 GHz. The one polarization product case shown in Figures 14 and 15 is only 2 GHz bandwidth with only one baseband active. In the figures blue lines indicate routing for LL products, green for LR products, red for RL products, and purple for RR products. The correlator chip resources that are used are also outlined with bold boxes in the associated colors.



**Figure 10** Correlator chip data routing for VLBA x VLA correlations with four polarization products and two baselines per correlator chip.

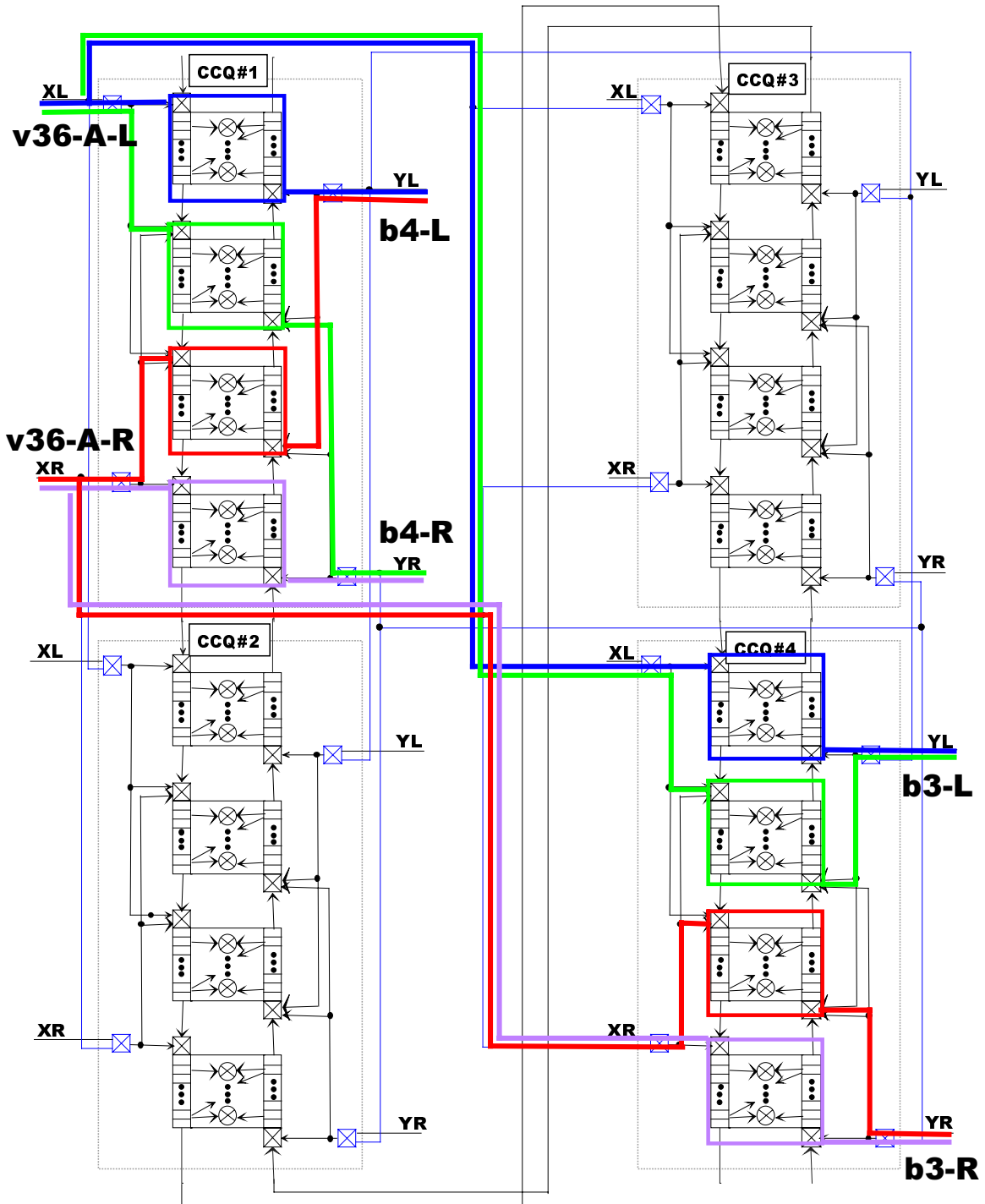
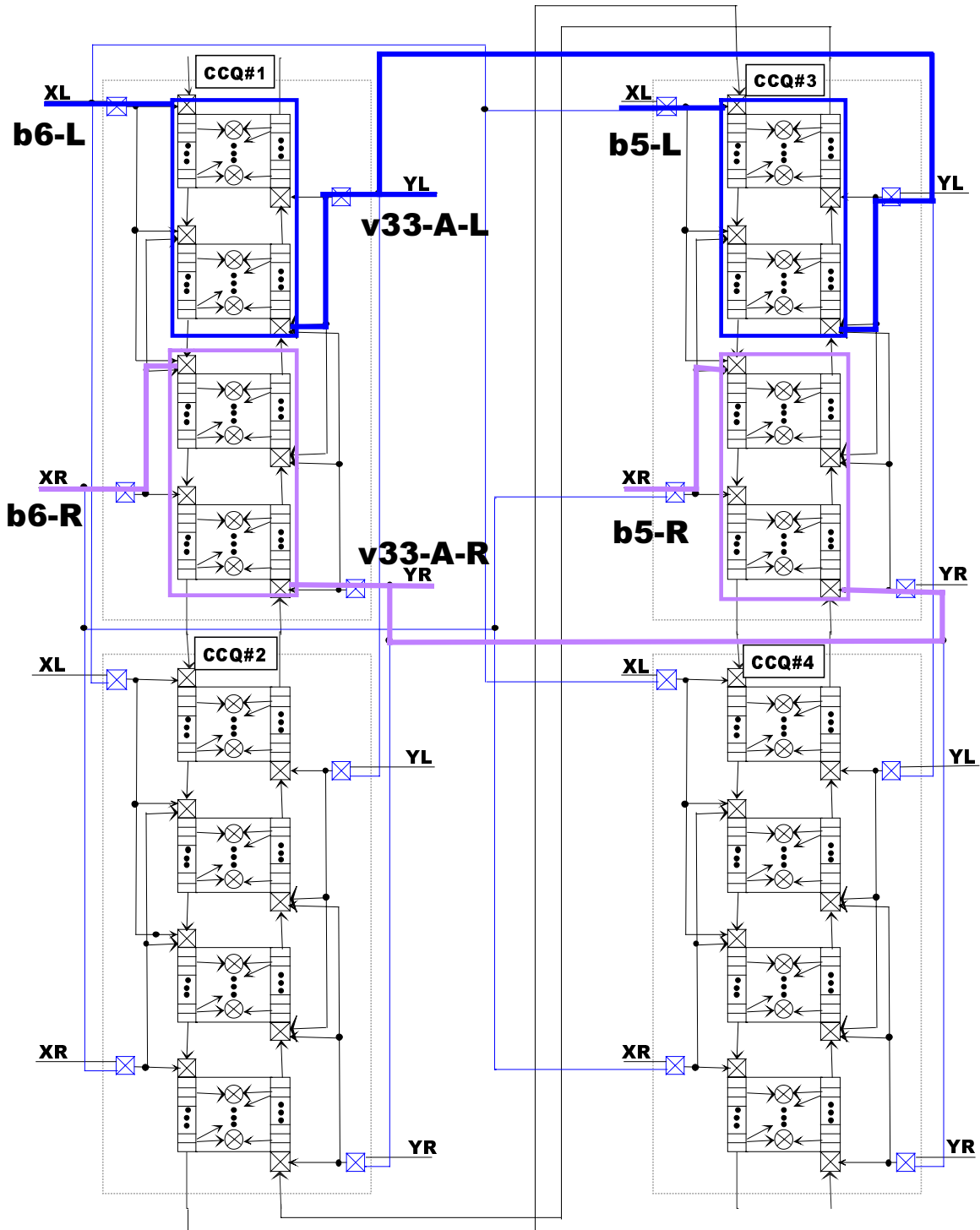
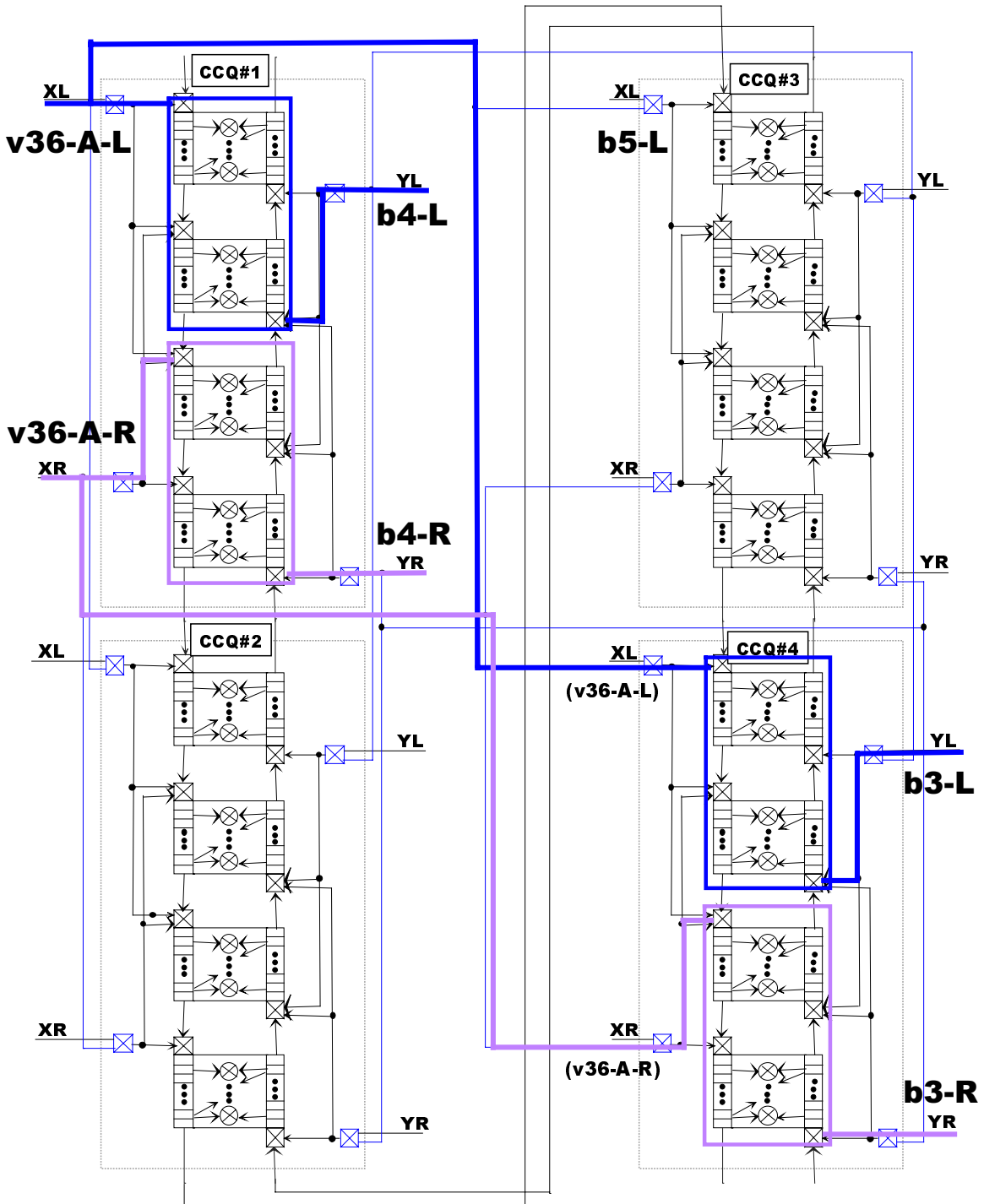


Figure 11 Correlator chip data routing for VLA x VLBA correlations with four polarization products and two baselines per correlator chip.

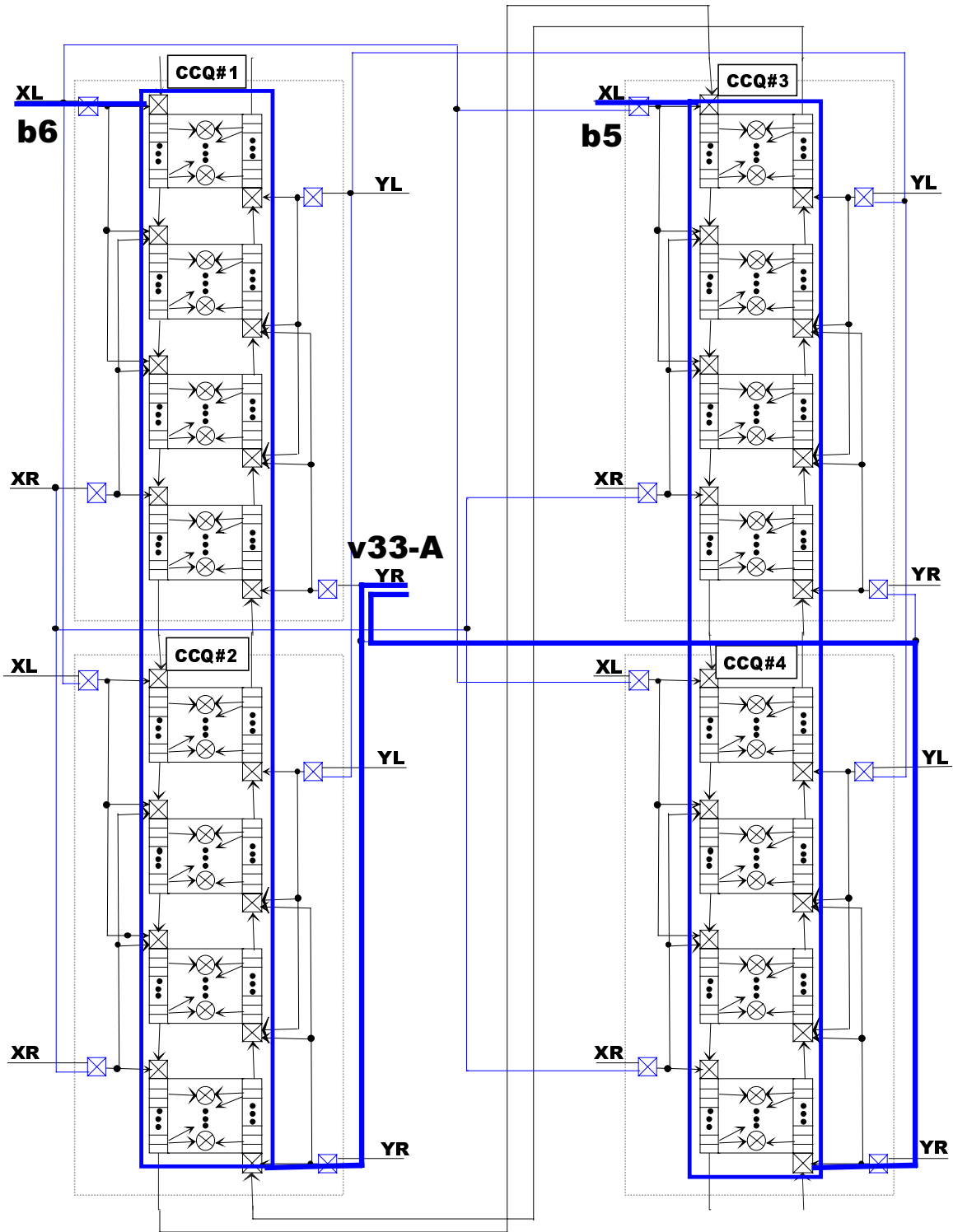


**Figure 12** Correlator chip data routing for VLBA x VLA correlations with two polarization products and two baselines per correlator chip. This can either be two polarization products or 2 x 1 polarization product at 2 GHz (using all 16 sub-band correlators of course!) each.

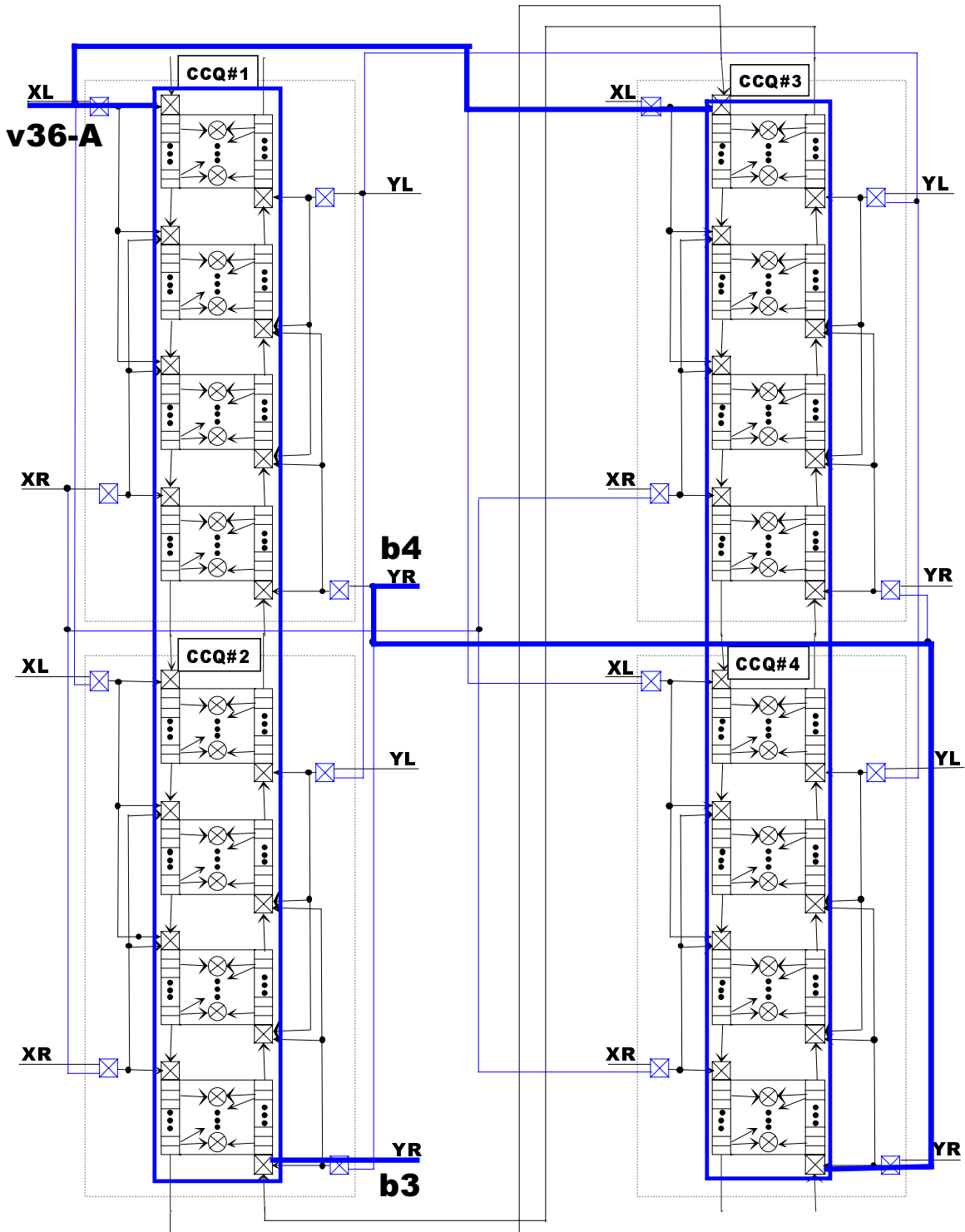




**Figure 13** Correlator chip data routing for VLA x VLBA correlations with two polarization products and two baselines per correlator chip. This can either be two polarization products or 2 x 1 polarization product at 2 GHz (using all 16 sub-band correlators of course!) each.



**Figure 14** Correlator chip data routing for VLBA x VLA correlations with one polarization product and two baselines per correlator chip. In this case, only 2 GHz of bandwidth is used, but the number of available lags has doubled (for example, compared to Figure 12).

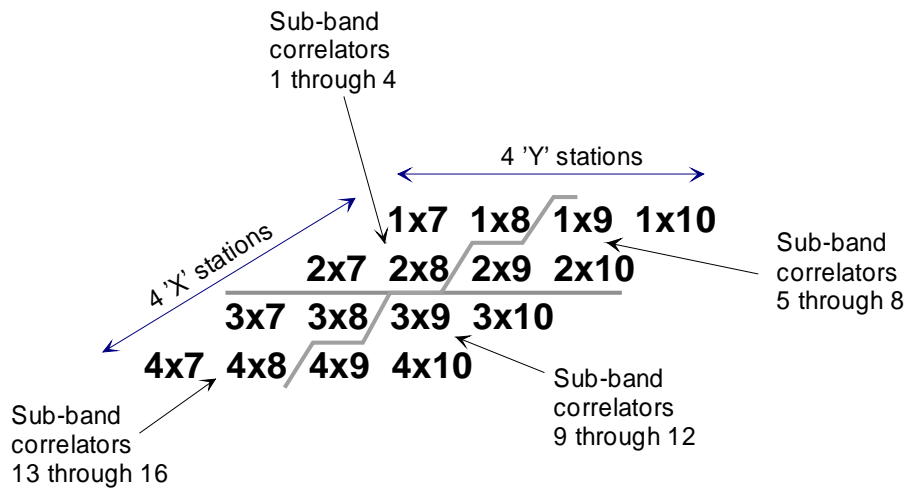


**Figure 15** Correlator chip data routing for VLA x VLBA correlations with one polarization product and two baselines per correlator chip. In this case, only 2 GHz of bandwidth is used, but the number of available lags has doubled (for example, compared to Figure 12).

**3.4 1 GHz Antenna Correlation**

All of the previous discussion regarding correlating 4 GHz antennas with each other and with 16 GHz antennas also applies to 1 GHz antennas. It was previously stated that, in the 1 GHz antenna case, for every unused 16 GHz correlator input four 1 GHz antennas could be correlated. Since there are four Station Boards per 16 GHz correlator input, this means that each 1 GHz antenna uses one Station Board, but it cannot use all of the sub-bands. Thus, the factor of four increase in number of baselines that must be correlated with 1 GHz antennas compared to 4 GHz antennas is made up for by *distributing the baseline correlations across sub-band correlators*. Since four times as many baseline correlations are required, then ¼ of the sub-band correlators are used to correlate each of the set of four baselines. This does require that the four sub-bands of interest are able to be replicated on the 16 sub-band outputs of the Station Board (for that baseband). This is already a requirement of the Station Board and so does not add additional routing.

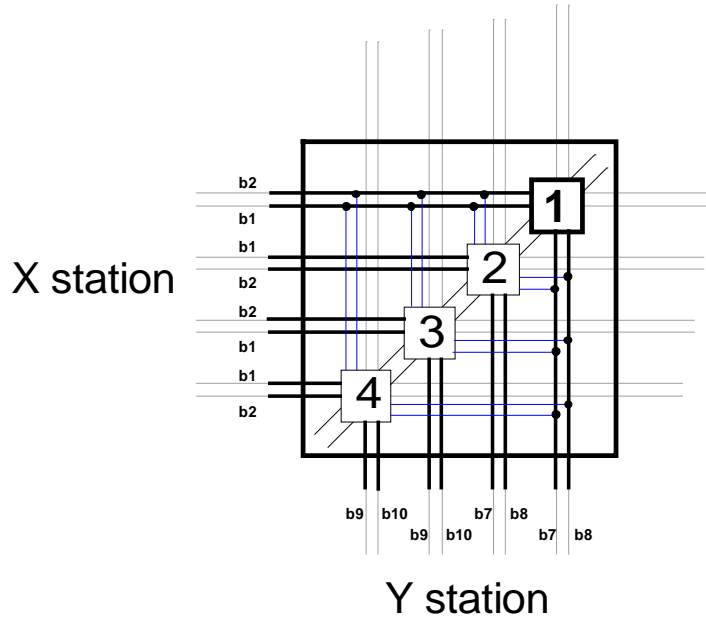
A parallelogram of some arbitrarily large baseline matrix that illustrates 1 GHz antenna correlation is shown in Figure 16. The 4x4-station parallelogram represents the correlations that must be done for each ‘quad’ of X and Y stations. A (X or Y) quad of stations fits into four Station Boards and all of the data for the quad (for a particular sub-band) fits on one cable going into one input of a Baseline Board. The 2x2 parallelograms get correlated in a particular correlator chip, with each group of four sub-band correlators being able to correlate the four sub-bands. Different sets of four baselines within the 16 are correlated by different sets of four sub-band correlators by changing the output data routing of the appropriate station receiver FPGA on the Baseline Board.



**Figure 16** A 4x4 parallelogram of some arbitrarily large baseline matrix. Each antenna is 1 GHz and feeds into one Station Board. Each 2x2 “sub”-parallelogram gets correlated in a particular correlator chip using a set of four sub-band correlators. Thus, only four (polarized) sub-bands can be correlated.

In the special case where it is desired to maximize bandwidth on one polarization, 8 sub-bands of one baseband (on the Station Board) will be used and the sub-bands in the other baseband will be ignored. In this case, it is necessary to split all of the 16 baseline

correlations into two groups of 8 baselines each: 8 sub-band correlators will correlate one group, and the other 8 sub-band correlators will correlate the other group. The station sub-band data routing to a correlator chip for VLBA-only (1 GHz x 1 GHz) correlations is shown in Figure 17 for the top half of the parallelogram shown in Figure 16. The data routing will be performed by the station receiver FPGA on the Baseline Board.



**Figure 17** Correlator chip and 1 GHz station assignments for correlating all 8 baselines in the upper half of Figure 16. These are the assignments for 8 sub-band correlators—the other 8 sub-band correlators have different assignments to correlate the bottom 8 baselines.

Similar routings will allow full bandwidth correlation and 1 polarization product with any combination of 1 GHz, 4 GHz and 16 GHz antennas.

## 4 Synopsis and Additional System Organization Issues

As previously mentioned the correlator itself can be internally wired-up for full 40-station, 16 GHz capability<sup>6</sup>. Depending on what antennas get connected to what station inputs, a station can be 16 GHz, 4 GHz, or 1 GHz using four Station Boards, one Station Board (all sub-bands), or one Station Board (only four sub-bands) respectively.

In the 16 GHz antenna case, data for all four baseband pairs goes into the four Station Boards. Data for all four baseband pairs of a particular sub-band gets routed to one sub-band correlator. The 16 sub-band correlators are thus able to correlate all 16 sub-bands of all baseband pairs.

<sup>6</sup> These conclusions came about during conversations with C. Walker.

In the 4 GHz antenna case, two of the four available Station Boards making up one station input to the correlator are used—the other two Station Boards are idle. Each of the two active Station Boards has data coming into it from one 4 GHz antenna. Data is routed from all four Station Boards to sub-band correlators as usual, except that now two of the baseband pairs are inactive. Each input to the Baseline Board contains data from two antennas, and with proper routing of the data from the receiver FPGA, correlator chips are able to do the necessary 4 baseline correlations.

In the 1 GHz antenna case, all of the available Station Boards making up one station input to the correlator are used. Each of the four active Station Boards has data coming into it from one 1 GHz antenna. Data is routed to the sub-band correlators, and each receiver FPGA on the Baseline Board has access to one sub-band of one baseband pair from four antennas. Receiver FPGA routing now allows four baselines to be correlated on each correlator chip, but with different sets of four sub-band correlators correlating different baselines that make up the required 16. If full bandwidth, single polarization correlations are required, then 8 baselines are correlated on each correlator chip, but with different sets of 8 sub-band correlators correlating different baselines that make up the required 16.

With a 40-station, 16 GHz WIDAR correlator, the 27 VLA antennas + 10 New Mexico Array antennas can be correlated with 16 GHz bandwidth. This leaves three unused station inputs that could be assigned (among others) as:

- 6 x 4 GHz antennas OR,
- 4 x 4 GHz antennas + 4 x 1 GHz antennas OR,
- 2 x 4 GHz antennas + 8 x 1 GHz antennas OR,
- 12 x 1 GHz antennas.

When real-time VLBA correlation is performed and the phased-VLA is used as one element, an additional 1 or 4 GHz (depending on how many Phasing Boards are in the system) input must be available. This is because feeding the phased-VLA output back into the correlator will most likely be performed by simply feeding the data into a spare Station Board—a subject of an upcoming memo.

Of course, the best reasonably affordable configuration that allows for a great deal of future expansion, would be a full 48-station correlator. This leaves room for an additional 11, 16 GHz inputs which could be configured to correlate 22, 4 GHz antennas all the way up to 44, 1 GHz antennas. The additional cost of a 48-station correlator is about \$2.5 million [1]. A tradeoff between a full 48 station correlator and a 40 station correlator would be to populate each of the 16 sub-band correlators with another Baseline Board whose sole purpose is to perform non-real time correlations. In this case 16, 4 GHz non-real time VLBA antennas could be correlated. VLBA antennas that could operate in real-time (and can be switched between real-time and tape operation) would be included in the main correlator matrix as previously described. This option would also





require up to an additional 16 Station Boards for a total additional cost of about \$0.5 million.

Since the internal wiring (station-to-baseline) of the correlator is independent of how many antennas are 16 GHz, 4 GHz, or 1 GHz, it is possible to change antenna bandwidths and assignments by allowing the (fiber-optic) receiver daughter board on the Station Board to select one of several inputs. (This is a suggestion by C. Walker to allow the possibility of 16 GHz correlation with VLBA antennas when the VLA is only using 1 or 4 GHz.) The number of inputs that can be selected will depend on the desired flexibility, the design of the daughter board, and the antenna data that is routed to it. Since TIMECODE must be the same for a group of four Station Boards (because there is one TIMECODE in every sub-band cable that contains all baseband pairs), sub-arraying for non-real time antennas is somewhat restricted. In this case, there must be a switch, external to the group of four Station Boards, that selects between the real-time TIMECODE and one or more<sup>7</sup> non-real time TIMECODES.

The data coming from the VLBA antennas does not have to be wideband (i.e. time-demultiplexed and using up as many data streams as possible). Each data stream could be sampled data from a single analog sub-band at the maximum sample rate or lower. Or, the data could be demultiplexed but not derived from data sampled at the maximum original sample rate. For example, a 4 GHz antenna could have sampled 8 analog basebands with a bandwidth of 512 MHz each. In this case, each sampled baseband's data is time-demultiplexed across four data streams. The FIR filters perform  $\frac{1}{4}$  band filtering and decimation to produce four sub-bands for each 512 MHz baseband. This can be accomplished by using the FIR filters in parallel (i.e. poly-phase) mode, but with unused taps set to zero [4]. Virtually any combination of wider and narrower input bandwidths can be accommodated provided all of the sample rates are appropriately related and the total number of available sampled data streams into the Station Board are not exceeded.

Finally, in the case where a sub-band derived from wideband data (that uses the WIDAR digital sub-sample delay tracking) is to be correlated with a sub-band generated by an analog filter and then sampled, it is necessary to be able to zero the station delay<sup>8</sup> before the baseline delay calculation in the correlator chip. This is because the wideband-derived sub-band no longer has any delay error, but the analog-derived sub-band still has a digital delay error that must be made to be zero at the center of the band [5]. Zeroing the station delay (from either X or Y) before performing the baseline delay calculation is performed by the receiver FPGA on the Baseline Board since it is a station-based function<sup>9</sup>.

<sup>7</sup> i.e. more than one non-real time TIMECODE if multiple observations are to be correlated simultaneously.

<sup>8</sup> This does not, however, apply to phased-VLA sub-band outputs that are fed back into the correlator.

<sup>9</sup> The delay *cannot* be zeroed on the Station Board, since the delay is still required to generate the phase offset for WIDAR digital delay tracking.



## 5 Conclusions

This document has shown in sufficient detail that it is possible to tradeoff antenna bandwidth for number of antennas while still keeping the internal wiring of the correlator set for “normal” full bandwidth operation. Generally, there are some additional routing requirements for the correlator chip but in this first analysis, at least, the additional routing does not seem to be problematic in terms of additional power dissipation or chip area. These tradeoffs can be used to make full use of the correlator and allow up to an additional 12, 1 GHz VLBA (“+others”) antennas (or combinations of 1 GHz and 4 GHz antennas) to be correlated in the same 40-station correlator as 37, 16 GHz VLA and New Mexico Array antennas. With the right input daughter module for the Station Board, it should be possible swap antennas to allow choices of bandwidth for antennas as well as allowing simultaneous real-time and non-real time (tape-based VLBI) operation.

All of this flexibility means that the delivered 40-station correlator should allow all correlation functions for the ELVA and the VLBA to be merged into one machine. Thus, a new VLBA correlator essentially comes for free or for very little cost—a savings of several million dollars and years of development time. Additionally, merging all correlation functions into one machine facilitates a growth path for the eventual merger of all VLA and VLBA antennas into one array.

## 6 References

- [1] Carlson, B., A Proposed WIDAR Correlator for the Expansion Very Large Array Project: Discussion of Capabilities, Implementation, and Signal Processing, NRC-EVLA Memo# 001, May 18, 2000.
- [2] Carlson, B., Summary of Discussions Held During the July 10-14, 2000 Workweek in Socorro Regarding the EVLA-WIDAR Correlator, NRC-EVLA Memo# 005—DRAFT, August 22, 2000.
- [3] Carlson, B.R., Dewdney, P.E., Burgess, T.A., Casorso, R.V., Petrachenko, W.T., Cannon, W.H., The S2 VLBI Correlator: A Correlator for Space VLBI and Geodetic Signal Processing, Publications of the Astronomical Society of the Pacific, 1999, 111, 1025-1047.
- [4] Carlson, B., A Closer Look at 2-Stage Digital Filtering in the Proposed WIDAR Correlator for the EVLA, NRC-EVLA Memo# 003, June 29, 2000.
- [5] Thompson, A.R., Moran, J.M., & Swenson, G.W., 1986, Interferometry and Synthesis in Radio Astronomy, Wiley, New York.

