

PULSECAL PHASE STABILITY—CURRENT STATUS

D.S. Bagri
1993Mar01

VLBA style pulsecal generators have now been installed at both Los Alamos and Pie Town antennas. This memo describes results of the phase stability tests on these antennas with the new pulsecal generators and their associated injection (distribution and cabling) scheme to various frontends. The block diagram in Fig. 1 gives a schematic of the pulsecal signal distribution to various frontends in an antenna. For the distribution of the pulsecal signal we have used low temperature coefficient (phase stable) cables as far as practical. Types of cables and their approximation lengths used in the system are shown in the block diagram. The expected temperature coefficients of the cables used and the pulsecal generator are also given in the block diagram. The block diagram of the test set up is shown in Fig. 2. The antennas were left in stow position during these tests. Figs. 3 and 4 give plots of temperature monitor data for PT antenna building and vertex room respectively for about 8 hours of test time on 93Feb01. Fig. 5 gives the cablecal monitor data, and Fig. 6 gives the pulsecal phases for various BBCs during the test time at PT. Figs. 7-10 are similar data for LA. From these data we see that the variations of the pulsecal phases for different BBCs track the cablecal variations roughly as expected (both in magnitude and sign). There is a few degrees peak to peak ($\leq 5^\circ/\text{GHz}$ of BBC LO frequency, which corresponds to about 1.6 ps) variation having periodicity of station building HVAC air temperature cycling (of about $5\text{-}7^\circ\text{C}$) at both PT and LA. This can be seen more clearly from data of 93Feb12 for LA (Fig. 11: Temperature plots, Fig. 12: Cablecal values, and Fig. 13: Pulsecal phases). This is probably due to the change in phase of the 5 MHz reference to various BBCs—variations required to be measured by the pulsecal phase monitoring system to correct phases of the astronomical signals.

During the test time temperature settings in the vertex rooms were varied by about 5°C at both PT and LA (Figs. 4 and 8). No obvious effects can be seen in the pulsecal phases at more than a couple of degrees (Figs. 6 and 10) corresponding to these temperature changes. It seems that pulsecal phases are fairly insensitive to the vertex room temperature changes. Overall the pulsecal phase monitoring system seems to perform at a few degrees accuracy which translates to less than a couple of ps for the 4 cm system where all these tests have been carried out. At this level we have to make astronomical observations in interferometer mode and use the pulsecal phases to correct the (astronomical) data, and see improvement in its quality to determine effectiveness of the (pulsecal phase measurement) system.

Phase glitches: In pulsecal phase plots for LA on 93Feb01 (Fig. 10) on four occasions there are phase glitches of about 10° in BBCs 1-6 (having 4cm band signals) and about $2\text{-}3^\circ$ in BBCs 7-8 (having 13 cm band signals). These glitches seemed to have lasted for about 1-2 min and it appears that these have been caused by pulsecal (rf) comb signal injected in the two (4 and 13 cm) frontends. We have earlier noticed this type of behaviour in VLBA design pulsecal system installed at PT but did not notice such a behaviour in old design 5 MHz based pulsecal generators at other antennas or even at LA. This, combined with the fact that we have

noticed some instability in laboratory in the 500 MHz driven comb generators, it is likely that this problem is caused by the 500 MHz driven comb generators used in these pulsed generator modules. Larry Beno has since modified these comb generators to eliminate the instability seen in the lab. The modified units have been installed both at PT and LA. Pulsed phase data taken at LA for more than 100 hours with the modified comb generator have not shown any glitches (i.e. Figs. 13 and 14) simultaneously in all BBCs (there have been some occasional glitch in a BBC—mostly one data point at a time, which may be due to other parts of the system like connectors or monitor/control). Therefore it appears that this problem was associated with the instability in the comb generators, and is probably solved, but we will watch for it for sometime.

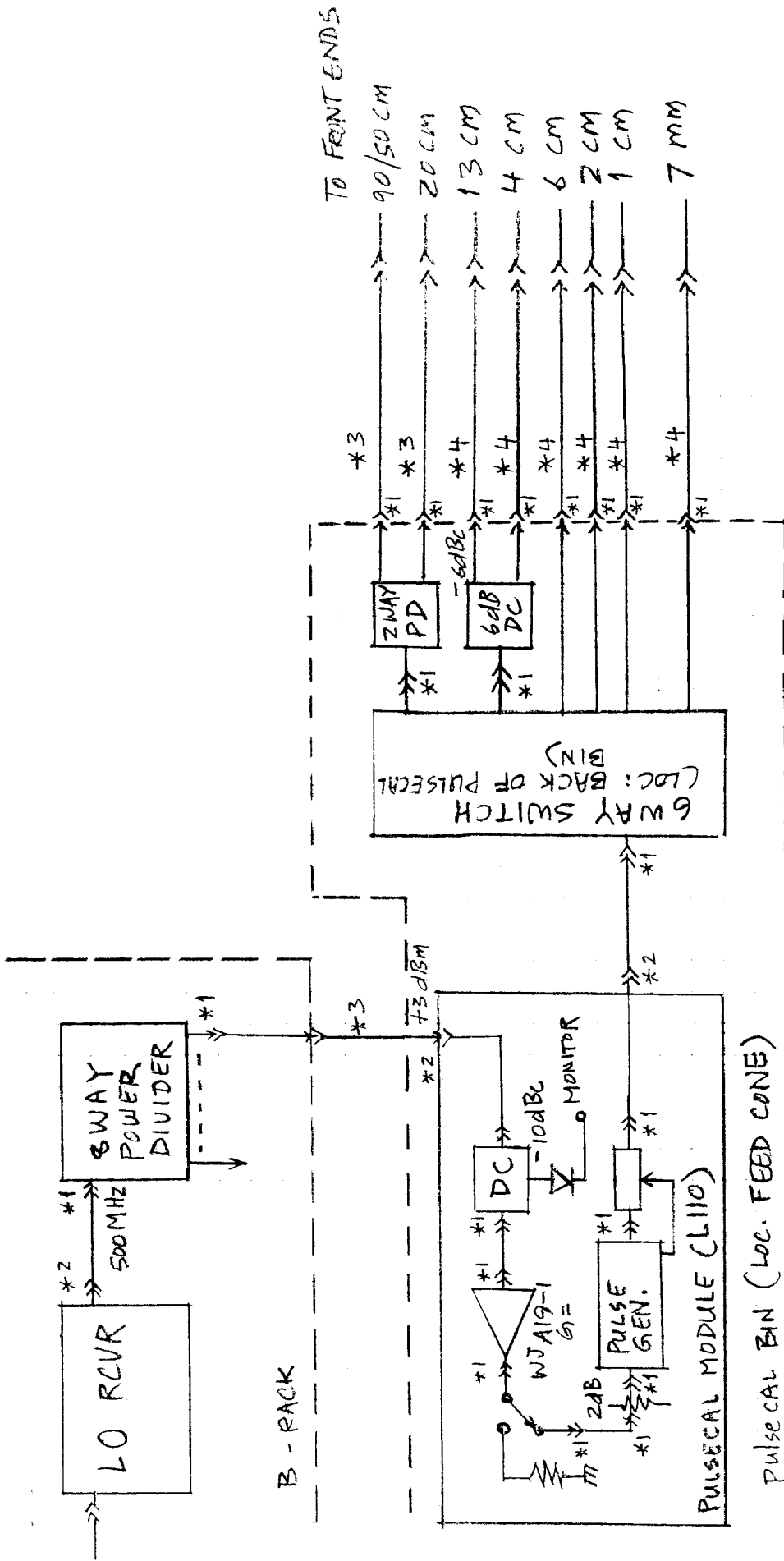

- *1 SMA
- *2 OSP
- *3 3/8" HELIAX CABLE (ANDREW) ± 9 PPM/°C
- *4 0.141 SEMI RIGID PRECISION MAKE (TYPE CIL 50141 : 17 PPM/°C)

FIG. 1 - PULSE CAL DISTRIBUTION BLOCK DIAGRAM

FIGURE 2 - OBSERVING SET UP

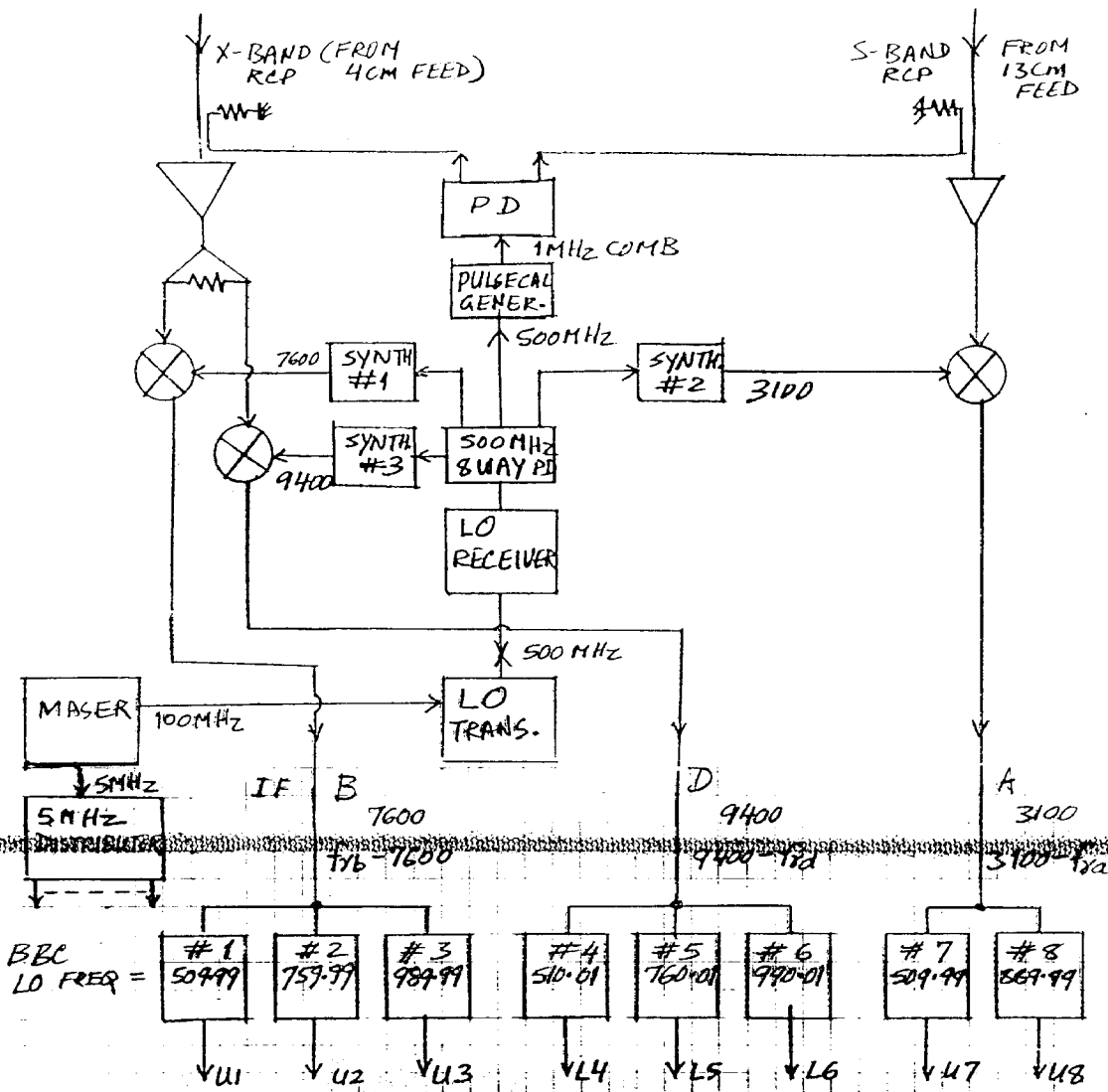

RF FREQ OF SIGNAL IN	BBC LO FREQ	RF FREQ	10kHz Tone RF FREQ
BBC 1,2,3	$f_{1,2,3}$	$7600 + \text{BBCLO}_{1,2,3} \cdot 01$	8110, 8360, 8590 MHz
4,5,6	$f_{4,5,6}$	$9400 - \text{BBCLO}_{4,5,6} \cdot 01$	8890, 8640, 8410
7,8	$f_{7,8}$	$3100 - \text{BBCLO}_{7,8} \cdot 01$	2590, 2210

phase of signal in BBC	BBC sideband	Frequency	Phase
1,2,3	U1, U2, U3	$f_{1,2,3} - 7600 - \text{BBC}_{1,2,3}$	$\phi_{f_{1,2,3}} - \phi_{7600} - \phi_{\text{BBC}_{1,2,3}}$
4,5,6	L4, L5, L6	$f_{4,5,6} + 9400 + \text{BBC}_{4,5,6}$	$\phi_{f_{4,5,6}} - \phi_{9400} + \phi_{\text{BBC}_{4,5,6}}$
7,8	U7, U8	$-f_{7,8} + 3100 - \text{BBC}_{7,8}$	$-\phi_{f_{7,8}} + \phi_{3100} - \phi_{\text{BBC}_{7,8}}$

PT 1993FEB01 - -BLDG. Temp.

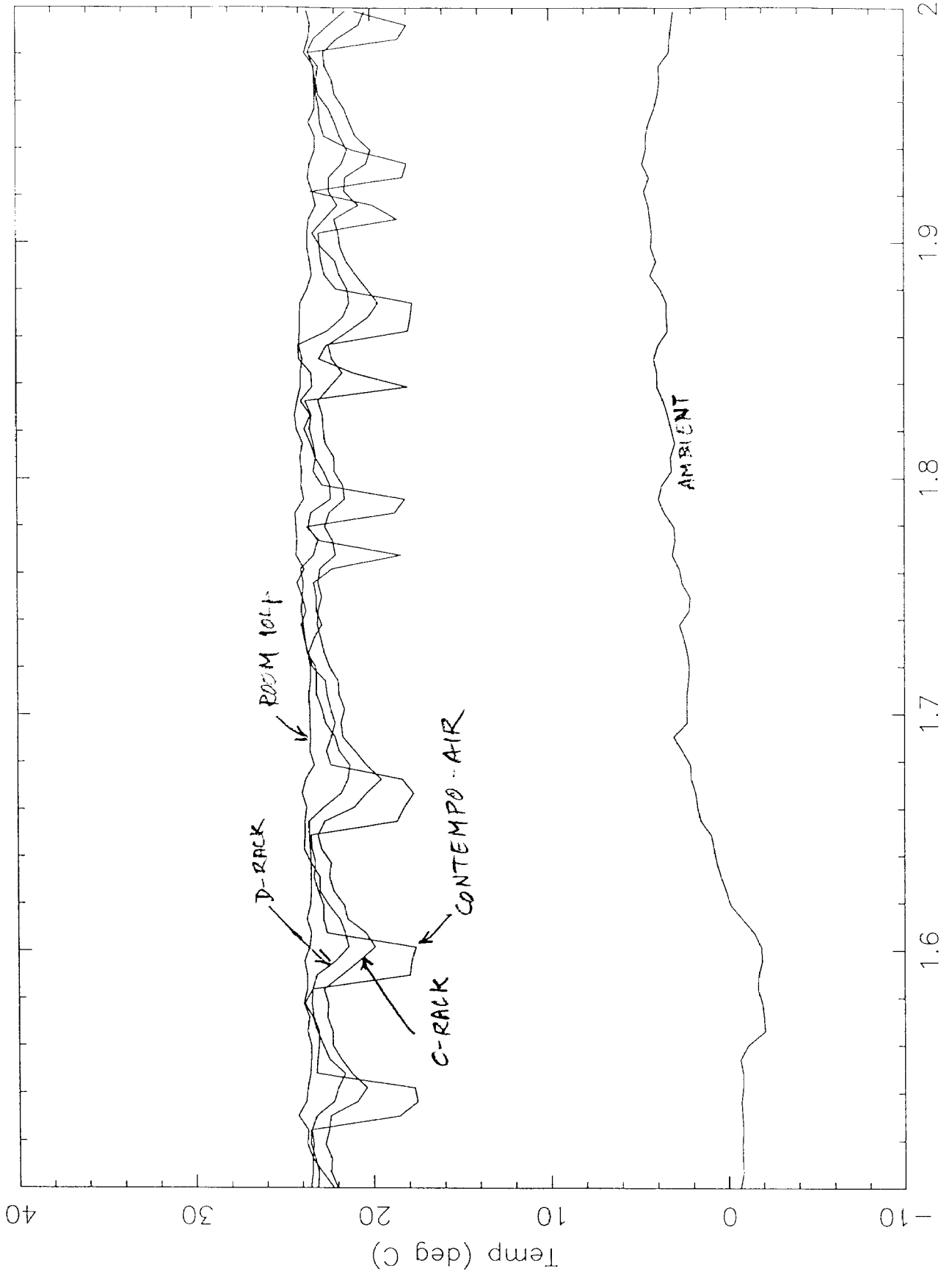

Time (days 1993Feb----

FIG 3

PT 1993FEBU, --VR Temp.

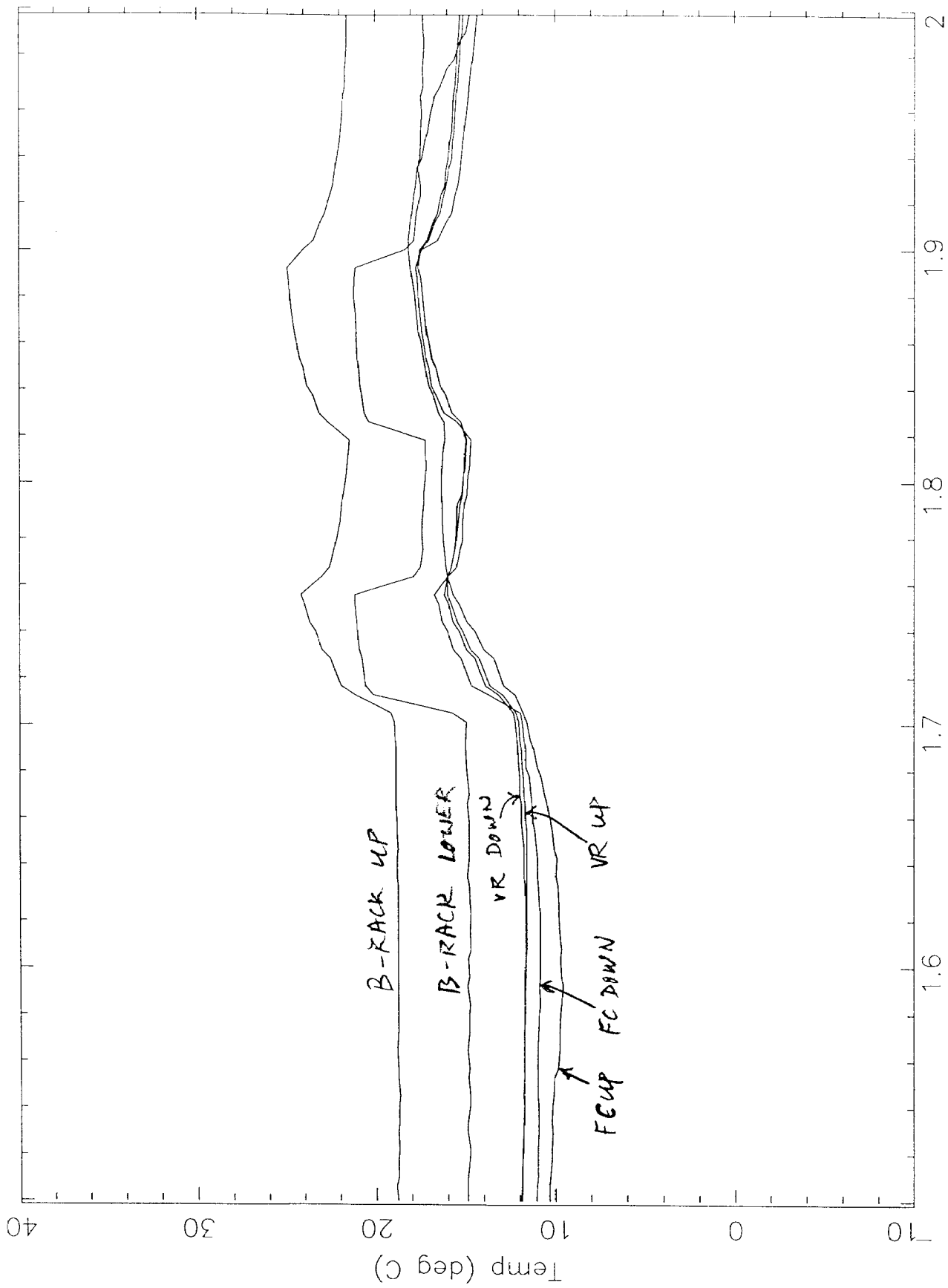

Time (days 1993Feb--)

Fig 4

PT 1993FEB01

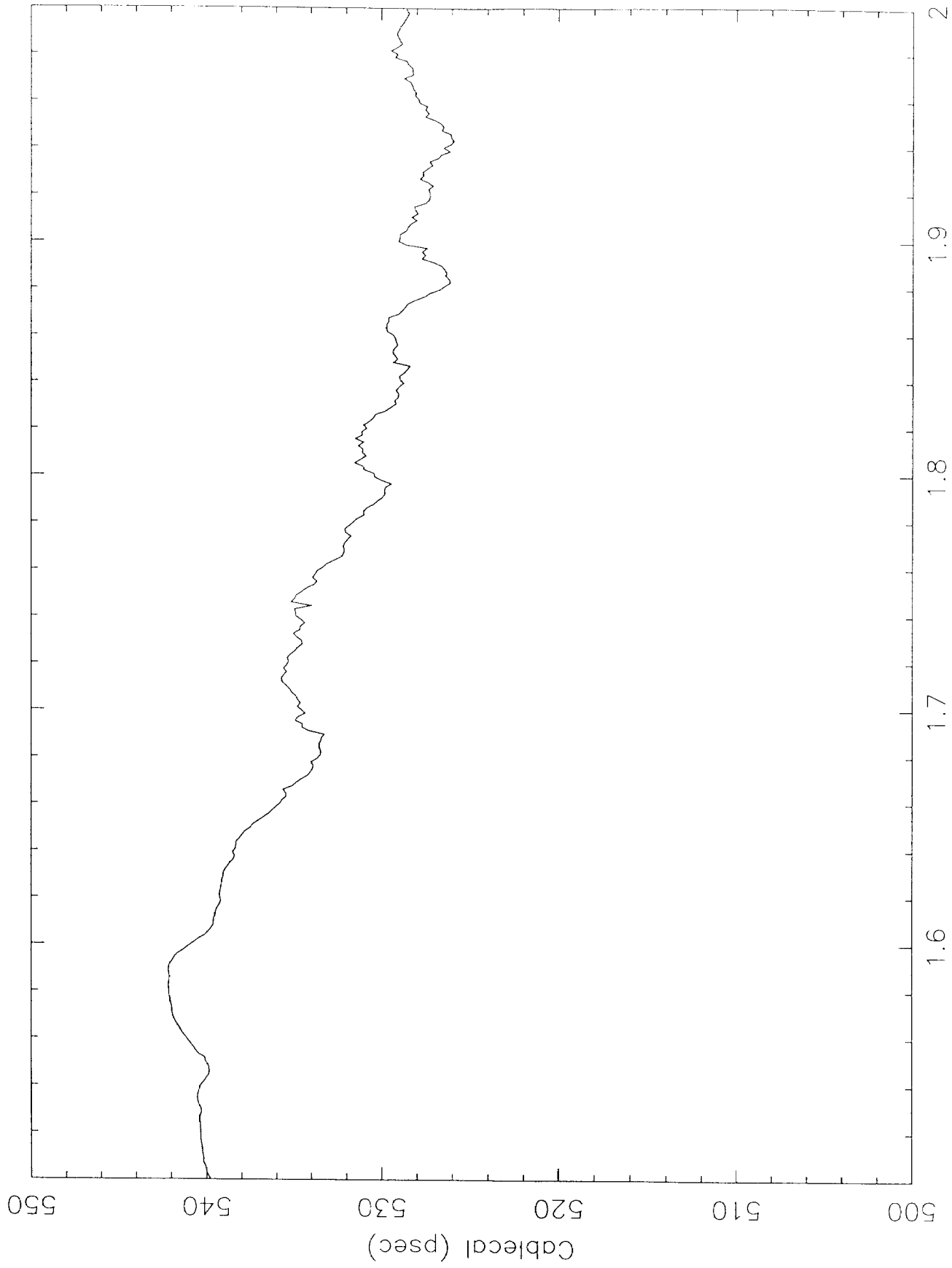

Time (days 1993FEB01)

Fig 5.

PT 1950 FEB --

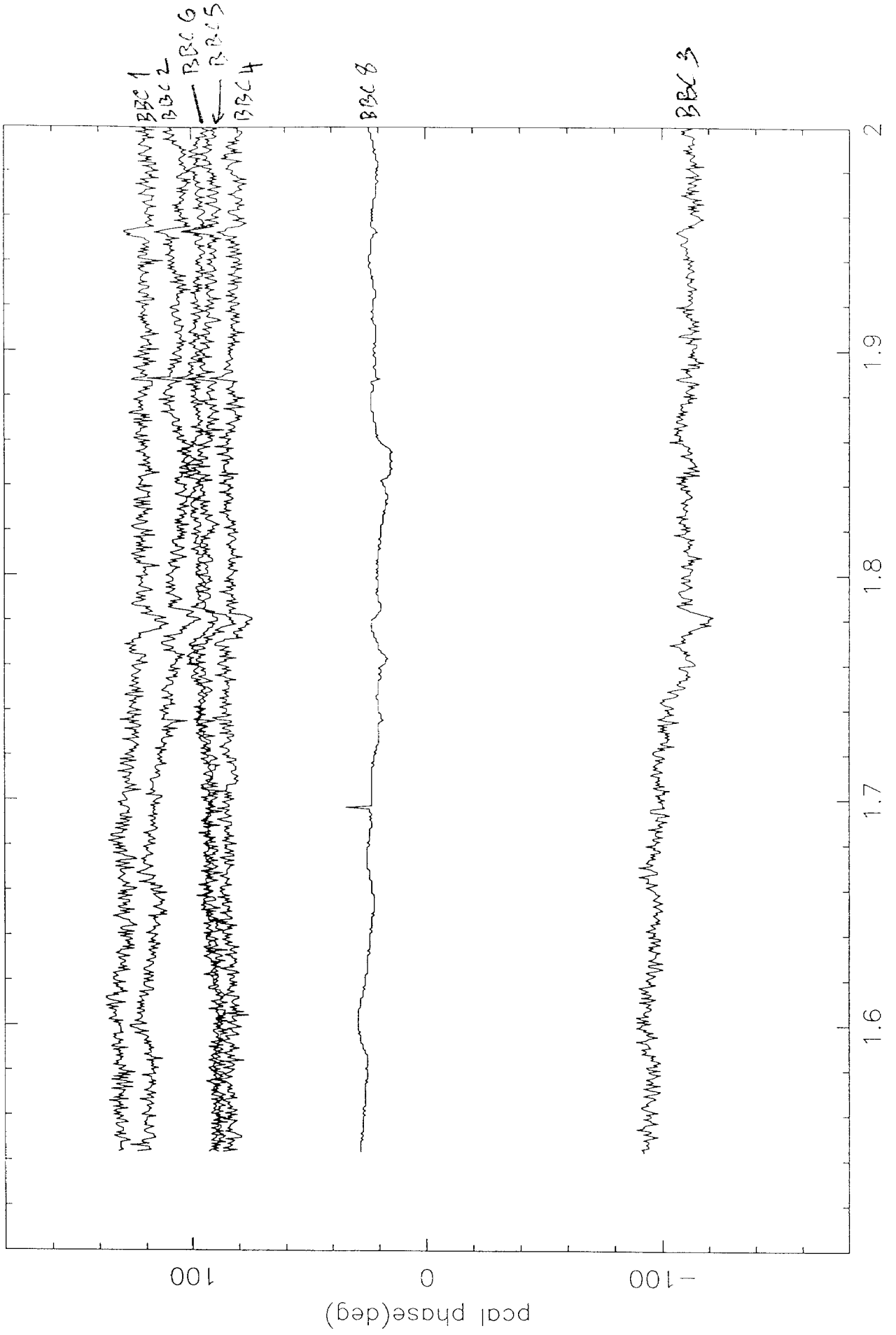

Time (days) 1950 FEB --

FIG. 6

LA 1993FEB01 --BLDG. Temp.

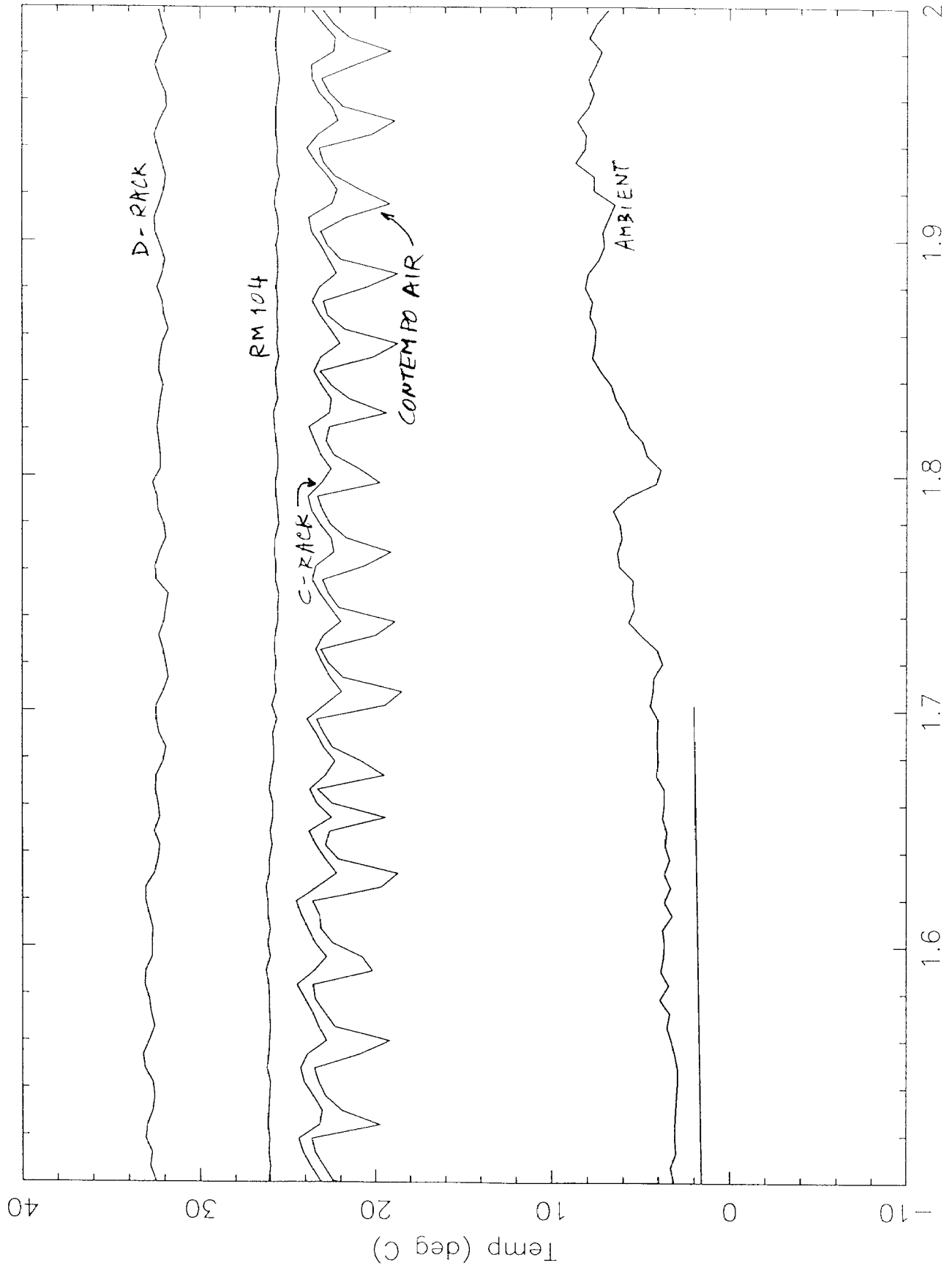

Time (days 1993Feb--)

Fig. 7

LA 1993FEBU1--VR Temp.

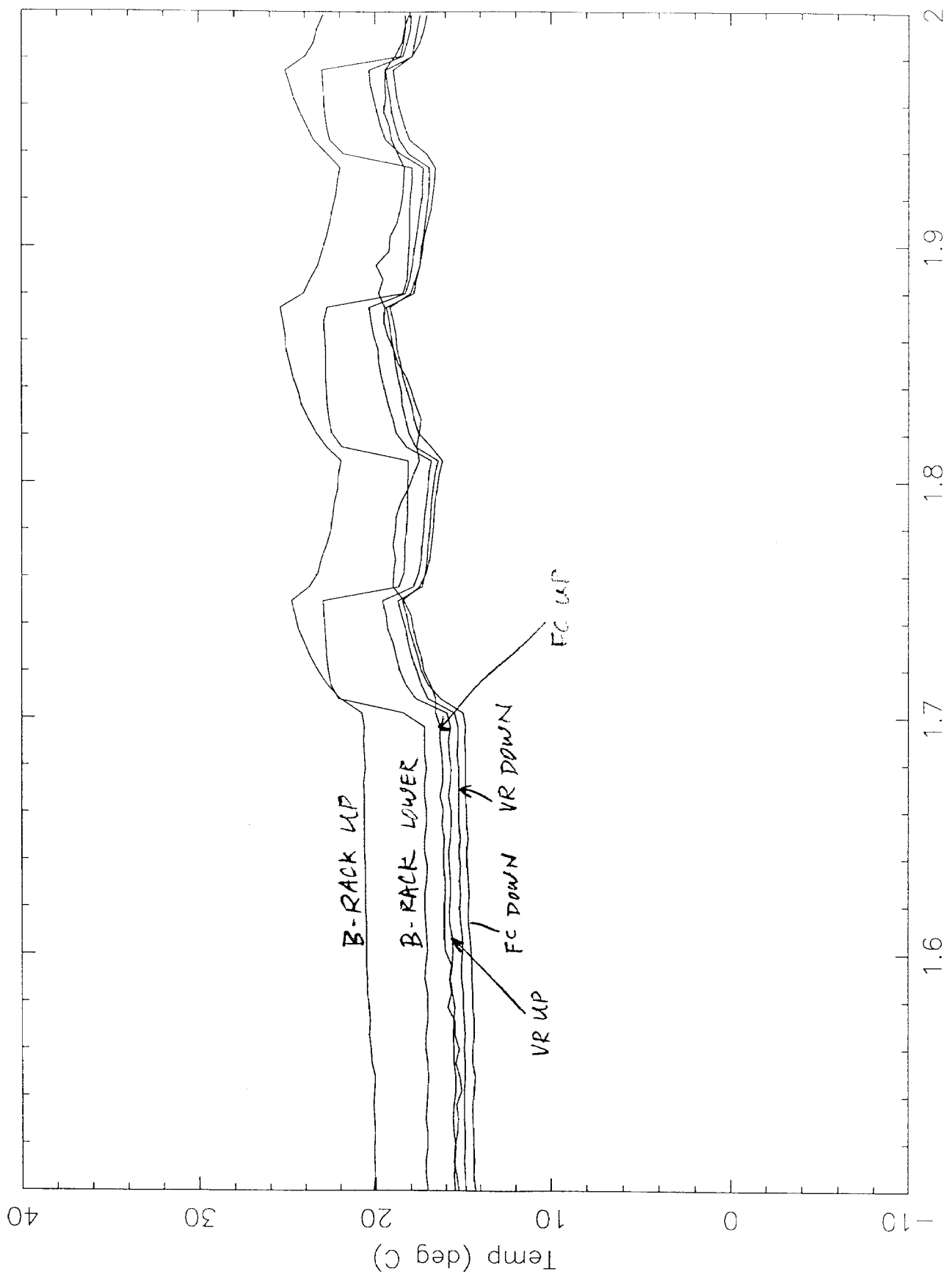

Time (days 1993Feb--)

FIG 8

LA 1993FEB01

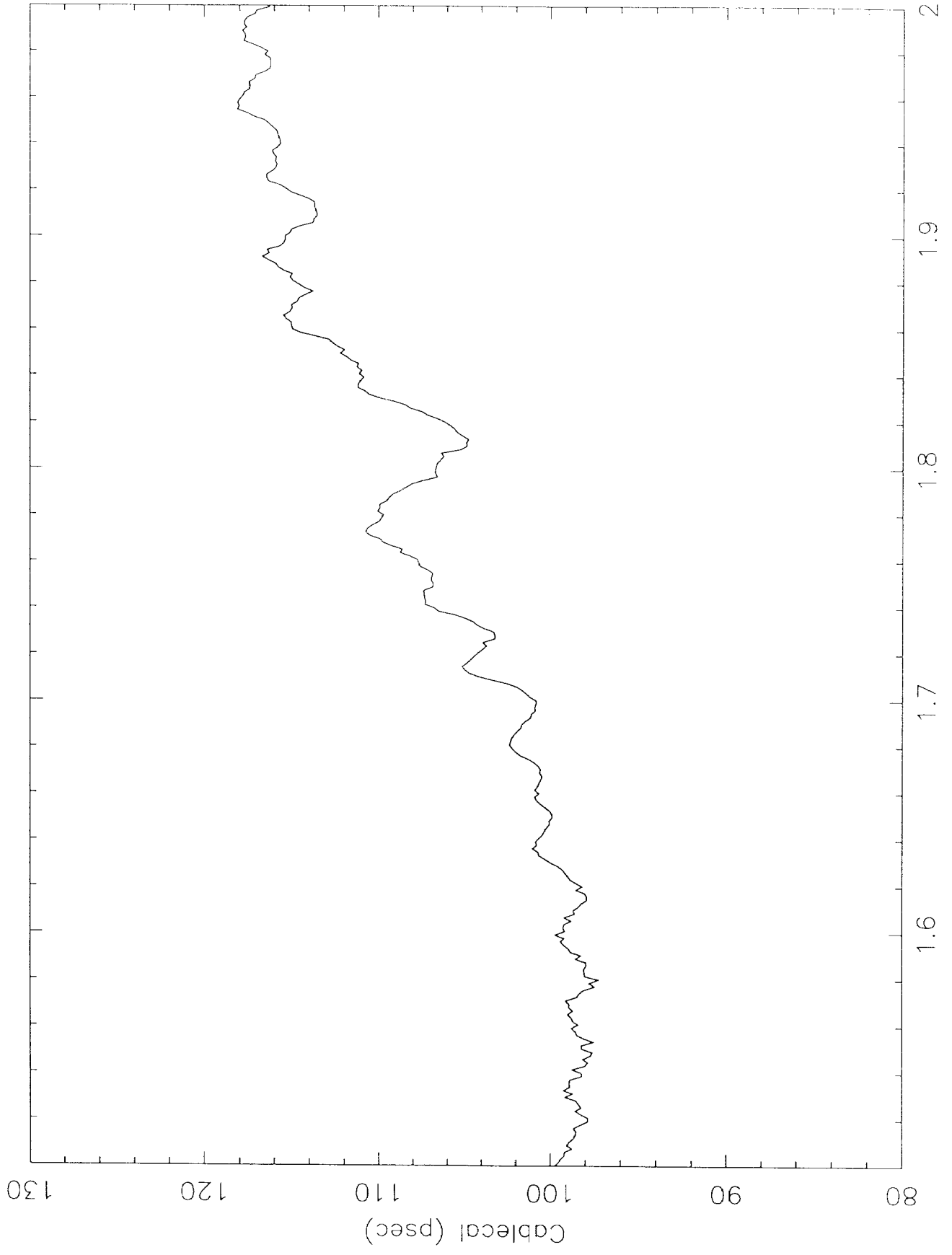

Time (days 1993FEB01)

Fig. 9

LA 1990 FEB --

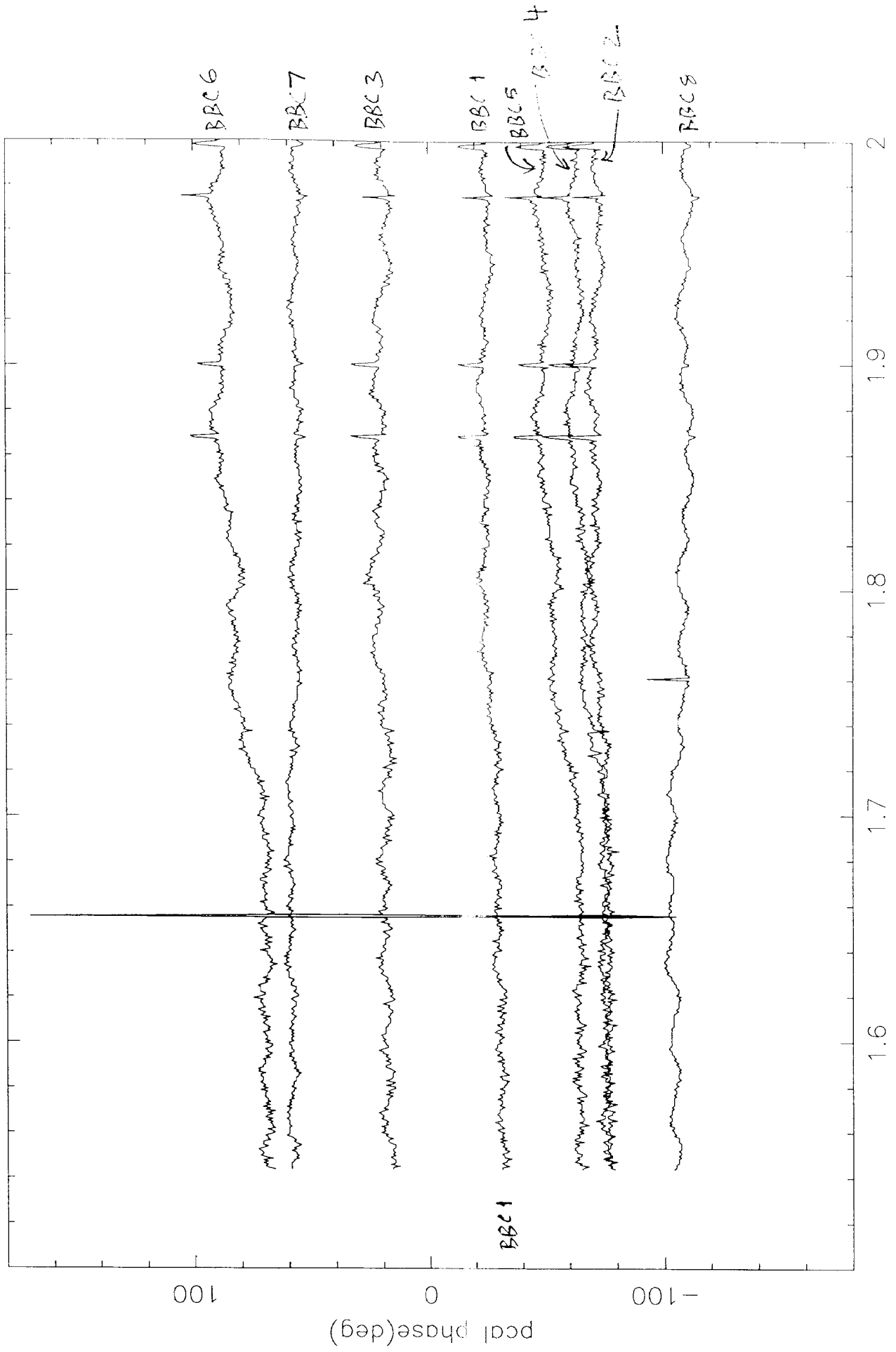
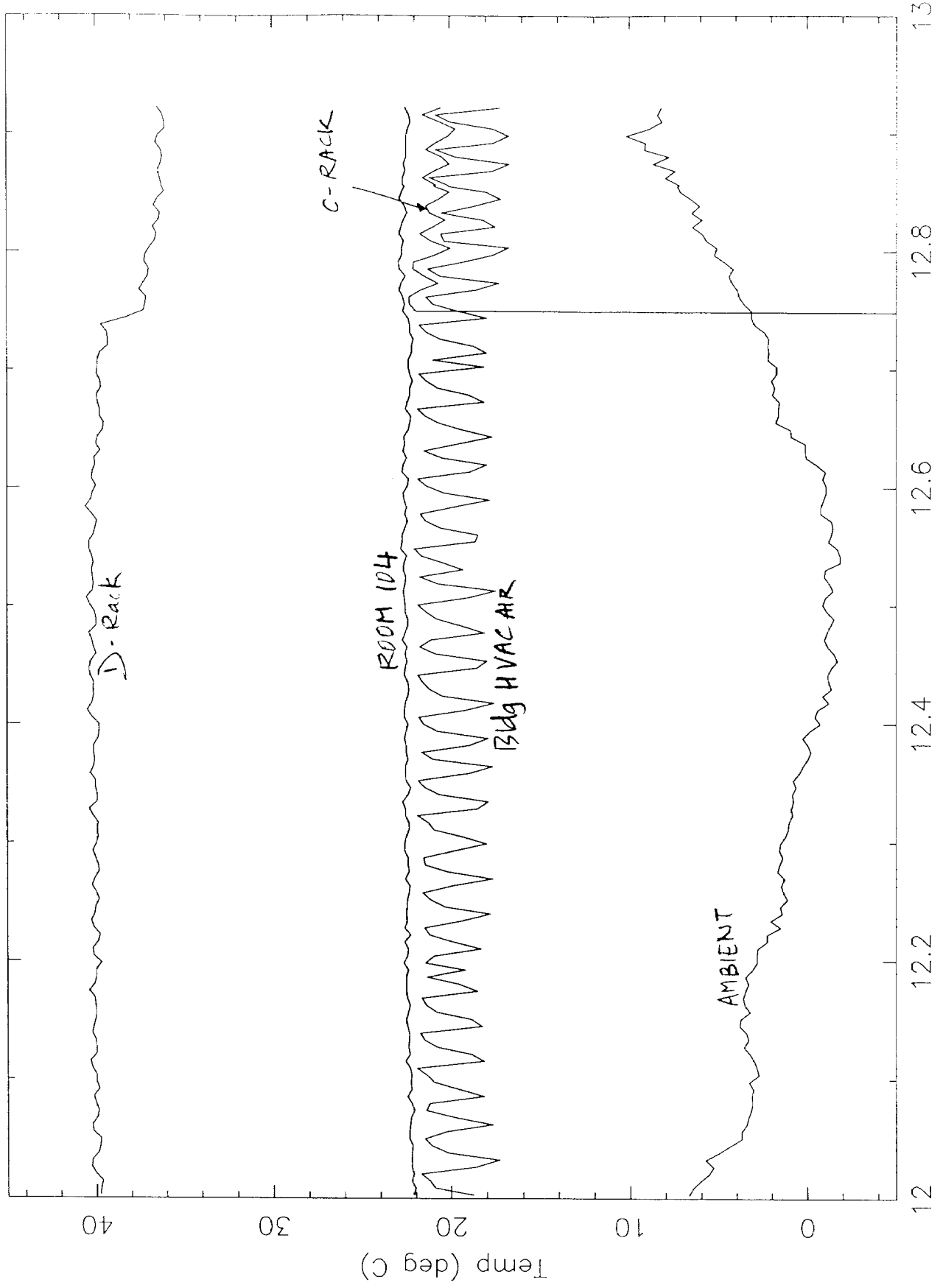

FIG. 10

Time (days 1993 FEB --)

LA 1993FEB--BLDG. Temp.



Time (days 1993Feb--)

FIG. 11

LA 1993 FEB --

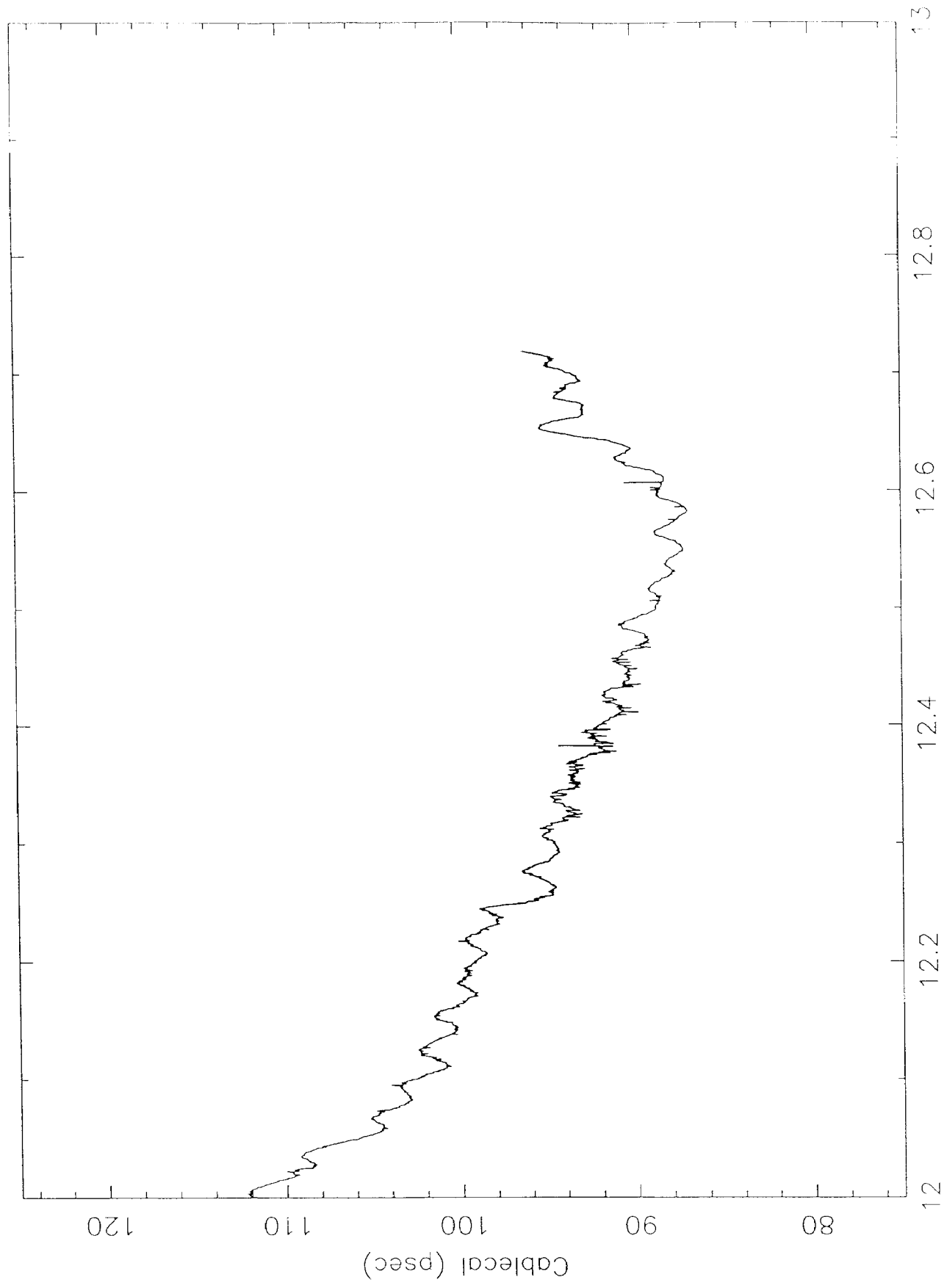

Time (days 1993 FEB --)

Fig 12

LA 1993FEB--
1993 Feb 12

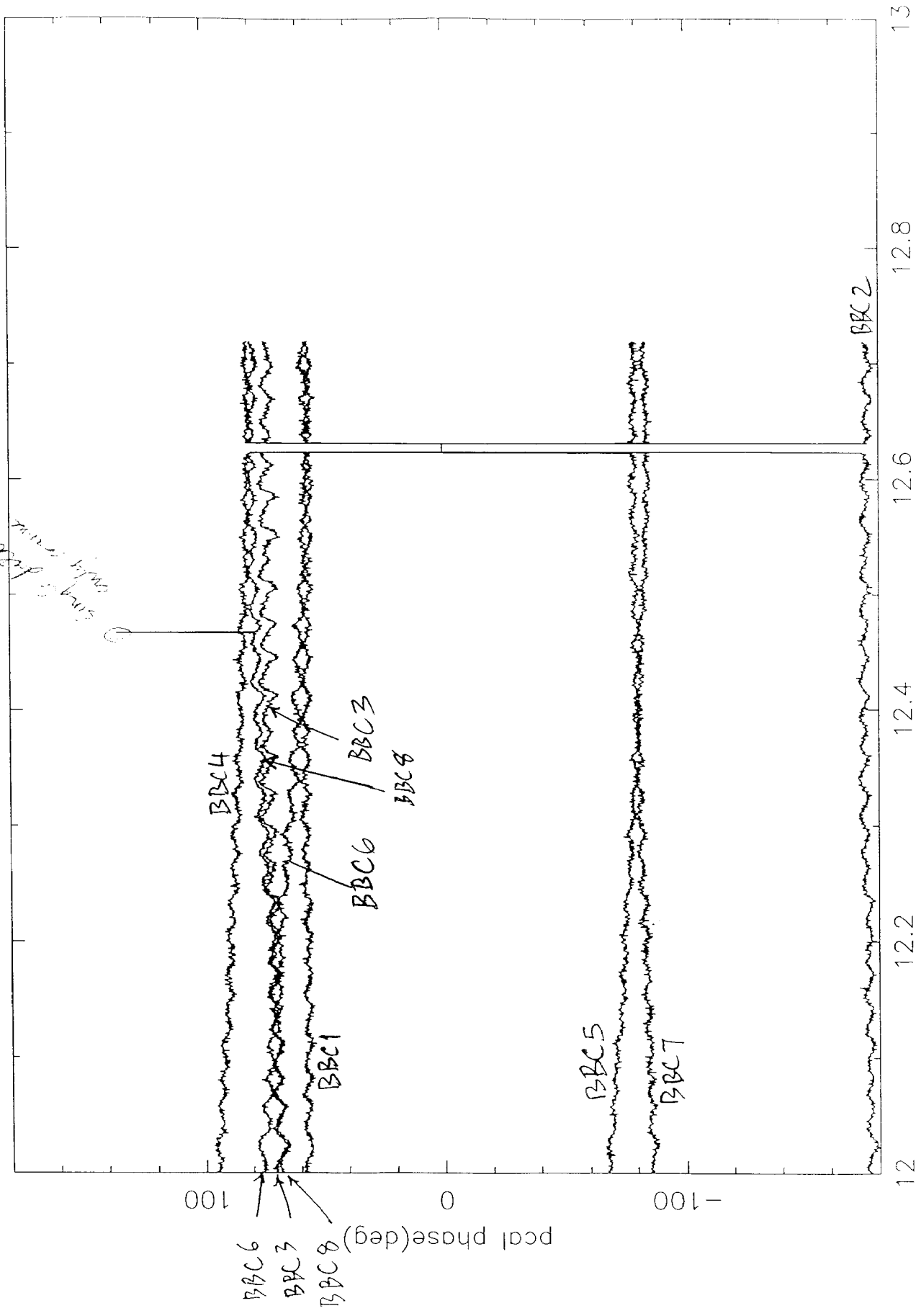

Time (days 1993FEB--)

Fig 13

LA 1993 FEB --

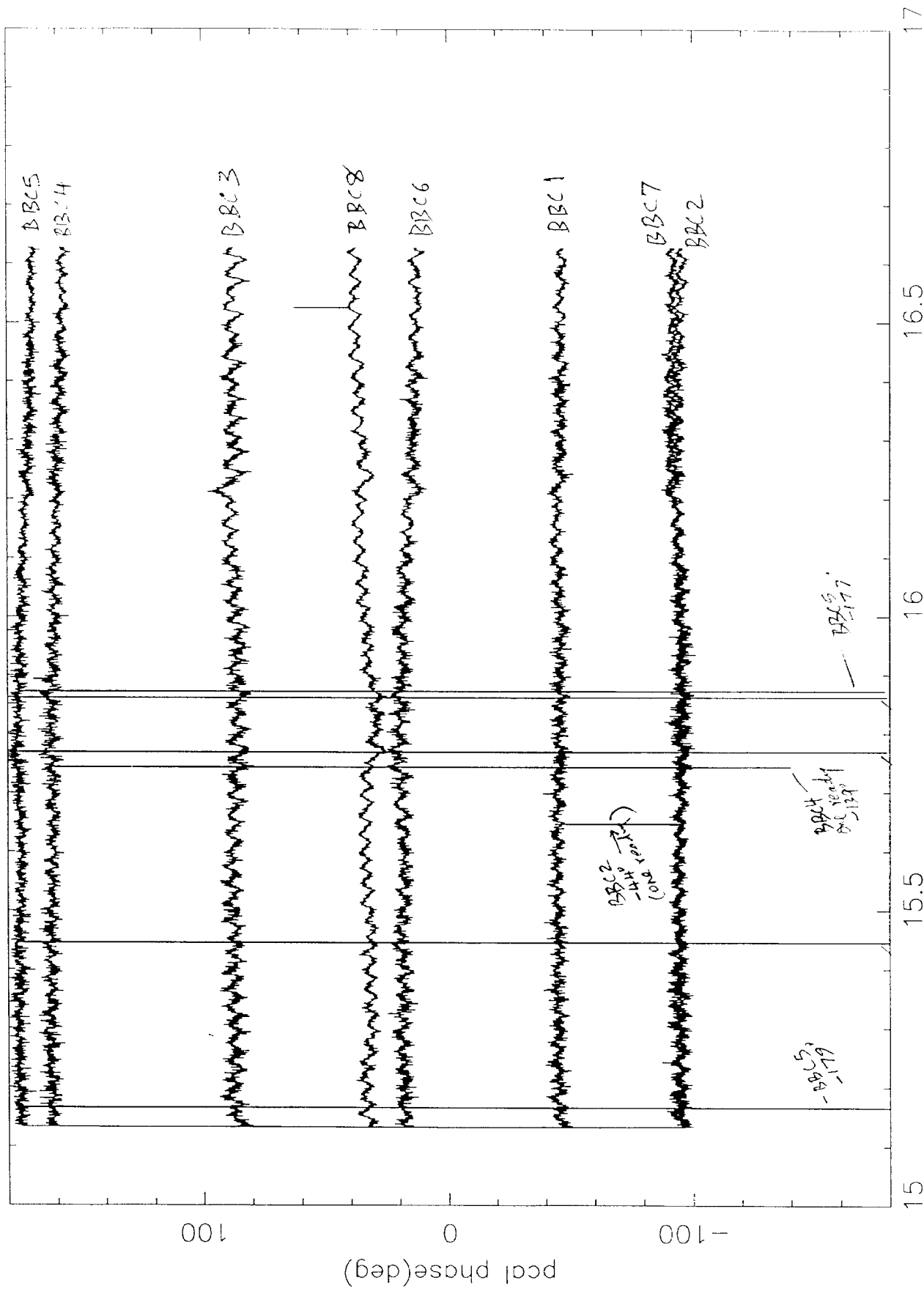

Time (days 1993FEB--)

Fig. 14